

2024



de
en
fr
pl

keeper







keeper
keeps your world

keeper



ecological
efficient
essential
enjoy living

Unsere Mission ist es, die Lebenswelt eines jeden Menschen zu verbessern, der Freude am Aufbewahren & Bewahren, Ordnen & Organisieren hat. Dafür entwickeln, designen und produzieren wir Kunststoff-Produkte für den alltäglichen Gebrauch im Haushalt. Jedes „e“ in **keeper** steht für eines der vier Markenversprechen: **ecological, efficient, essential – enjoy living!**

Our mission is to improve the lives of everyone who enjoys storing, keeping and organising. To achieve this, we develop, design and produce plastic products for everyday use in the home. Each „e“ in **keeper** stands for one of the four brand promises: **ecological, efficient, essential – enjoy living!**

Notre mission est d'améliorer le cadre de vie de chaque personne qui prend plaisir à ranger et à conserver, à classer et à organiser. Pour cela, nous développons, concevons et fabriquons des produits en plastique pour l'usage quotidien dans la maison. Chaque „e“ de **keeper** représente l'une des quatre promesses de la marque : **ecological, efficient, essential – enjoy living !**

Naszą misją jest poprawa jakości życia wszystkich tych, którzy odnajdują radość w porządkowaniu, przechowywaniu i organizowaniu. W tym celu opracowujemy, projektujemy i produkujemy produkty z tworzyw sztucznych do codziennego użytku domowego. Każde „e” w **keeper** oznacza jedną z czterech obietnic marki: **ecological, efficient, essential – enjoy living!**



gut zu wissen

Auf all unsere Produkte gewähren wir eine Garantie von 10 Jahren. Wir sind stolz darauf, eine eigene Produktion in der EU zu betreiben, die eco line Produkte werden dabei aus 100 % Recyclingmaterial hergestellt. Ein besonders schönes Geschenk war der Gewinn des Red Dot Design Awards für unseren beliebten Babytopf Deluxe 4 in 1 „kasimir“.

good to know

All our products come with a guarantee of 10 years. We are proud to have our own production in the EU. What's more the eco line products are made from 100 % recycled material. A particularly gift was winning the Red Dot Design Award for our popular "kasimir" baby potty deluxe 4-in-1.



3 Vertriebsstandorte in Europa / 2 Showrooms
3 distribution sites in Europe / 2 showrooms
3 sites de distribution en Europe / 2 showrooms
3 punkty dystrybucyjne w Europie / 2 showroomy



eigene Produktion nach ISO 9001:2015 zertifiziert
own production certified according to ISO 9001:2015
production propre certifiée ISO 9001:2015
własna produkcja certyfikowana ISO 9001:2015



eco line Produkte aus 100 % Recyclingmaterial
eco line products are made from 100 % recycled plastic
produits eco line 100 % recyclés
linia eco wykonana w 100% z materiału z recyklingu



10 Jahre Garantie auf alle Produkte
10 years guarantee on all products
10 ans de garantie sur tous les produits
10 lat gwarancji na wszystkie produkty



eigener Außendienst
own sales service
propre service extérieur
własny zespół sprzedaży



reddot winner 2022

bon à savoir

Nous accordons une garantie de 10 ans sur tous nos produits. Nous sommes fiers d'avoir notre propre production dans l'UE, les produits eco line sont ainsi fabriqués à partir de matériaux 100 % recyclés. Un cadeau particulièrement agréable a été l'obtention du Red Dot Design Award pour notre pot pour bébé Deluxe 4 en 1 kasimir™, très apprécié.

dobrze wiedzieć

Wszystkie nasze produkty objęte są 10-letnią gwarancją. Jesteśmy dumni, że mamy własną produkcję w UE. Co więcej, produkty z linii eco wykonane są w 100% z materiałów pochodzących z recyklingu. Szczególnym prezentem było zdobycie nagrody Red Dot Design Award za nasz popularny nocnik „Kasimir” Deluxe 4 w 1.

60

Jahre Tradition in Spritzguss
years of experience in injection moulding
années dans le moulage par injection
lat doświadczenia w formowaniu wtryskowym

1.2 mio.

verkaufte Klappboxen „ben” pro Jahr
folding boxes „ben” sold per year
boîtes pliantes „ben” vendues par an
sztuk koszy „ben” sprzedawanych rocznie

700

Katalogartikel im Sortiment
catalogue items in our range
articles dans l'assortiment
pozycji w katalogu

15.000 t

Materialverbrauch pro Jahr
material consumption per year
matériaux consommés par an
materiałów zużywanych rocznie

35 mio.

verkaufte Teile pro Jahr
sold pieces per year
pièces vendues par an
sprzedawanych rocznie

55

Länder, in denen wir Kunden beliefern
countries in which we supply customers
pays dans lesquels nous livrons nos clients
krajów, w których zaopatrujemy naszych klientów

20 %

des Verbrauchs ist Recyclingmaterial
of the material consumed is recycled material
de la consommation est du matériel recyclé
zużywanego materiału pochodzi z recyklingu

willkommen in unserer welt



Wer gerne Dinge aufbewahrt, sortiert, zubereitet und frisch hält, ist bei uns genau richtig. Entdecken Sie die Vielfalt von **keeper** in allen Lebensbereichen und finden Sie viele praktische Haushaltsprodukte, die im Alltag im wahrsten Sinne des Wortes nachhaltig helfen. Für eine einfache Unterscheidung unserer Produktkategorien haben wir ein Farbsystem entwickelt, das überall wiedererkennbar ist – vor allem am Point of Sale.

welcome to our world

Those who like to store, sort, prepare and keep things fresh, are right with us. Discover the diversity of **keeper** in all areas of life and find many practical household products that help in everyday life in the truest sense of the word sustainability. For an easy differentiation of our product categories, we have developed a colour system that is recognisable everywhere – especially at the point of sale.

bienvenue dans notre monde

Si vous aimez ranger, trier, préparer et garder les choses au frais, vous êtes à la bonne adresse. Découvrez la diversité de **keeper** dans tous les domaines de la vie et trouvez de nombreux produits ménagers pratiques qui aident durablement au quotidien, au sens propre du terme. Pour distinguer facilement nos catégories de produits, nous avons développé un système de couleurs reconnaissable partout - surtout sur le point de vente.

witamy w naszym świecie

Jeśli lubisz przechowywać, sortować, przygotowywać i utrzymywać świeżość, to dobrze trafiłeś. Odkryj różnorodność **keeper** we wszystkich obszarach życia i znajdź wiele praktycznych artykułów gospodarstwa domowego, które pomagają w życiu codziennym w najprawdziwszym znaczeniu słowa zrównoważony rozwój. Aby ułatwić rozróżnienie kategorii naszych produktów, opracowaliśmy system kolorów, który jest rozpoznawalny wszędzie – zwłaszcza w punkcie sprzedaży.



inhalt

2024

content
sommaire
spis treści

keeper
keeps your world



2 – 11

keeper eco



12 – 23



keeper kitchen



24 – 49



keeper home



50 – 75



keeper storage



76 – 109



keeper kids



110 – 151

keeper eco

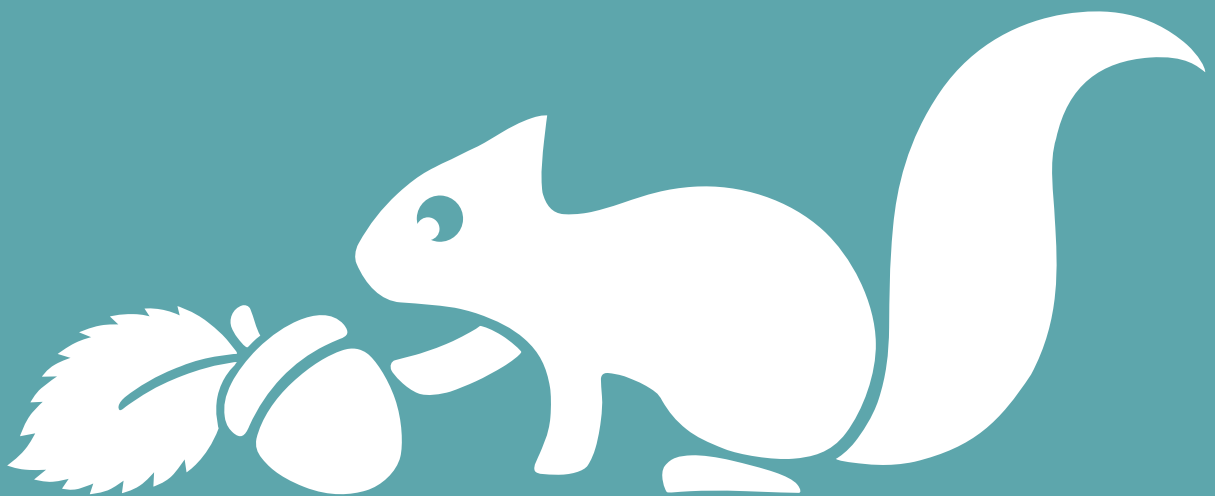

back to basics.

Unsere eco Produkte sind besonders ressourcenschonend, denn sie werden aus 100 Prozent Recyclingkunststoff hergestellt. Dieses sogenannte PCR (Post-Consumer Rezyklat) wird aus recyceltem Verpackungsmaterial gewonnen und ist dabei trotzdem frei von Verunreinigungen durch andere Kunststoffe. So hat ein **keeper** Produkt nicht nur ein Vorleben, sondern auch noch ein Leben danach, denn die **keeper** eco line ist gleich im doppelten Sinne ressourcenschonend: Sie wird nicht nur nachhaltig produziert, sondern auch nachhaltig entsorgt und recycelt. Und das frühestens nach zehn Jahren – darauf geben wir unser Wort.

back to basics.

Our eco products are especially resource-friendly since they are made from 100 percent recycling plastics. This so-called PCR (post-consumer recycled material) is sourced from recycled packaging material and is free from contaminations with other synthetics. Thus, a **keeper** product not only has a past life, but also a life hereafter, because the **keeper** eco line is resource-friendly in two senses: Not only is it produced sustainably, but also discarded and recycled in the same way. After ten years at the earliest - you have our word on that.

back to basics.

Nos produits écologiques préservent particulièrement les ressources, car ils sont fabriqués à partir de plastique recyclé à 100 pour cent. Appelés PCR (post consumer recycled material), ils sont obtenus à partir de matériel d'emballage recyclé, en étant malgré tout exempts des impuretés causées par d'autres plastiques. Ainsi, un produit **keeper** n'a pas seulement une vie antérieure, mais également une vie après, car l'eco line de **keeper** préserve les ressources à deux égards : Non seulement elle est produite de manière durable, mais elle est aussi éliminée et recyclée de manière durable. Et ce, au plus tôt après dix ans – vous avez notre parole.

eco produkty oszczędzają.

Nasze eco produkty oszczędzają zasoby naturalne, ponieważ są wykonane w 100% z plastiku pochodzącego z recyklingu. Tak zwany PCR (post consumer recycled material) powstaje z przetworzonych materiałów opakowaniowych i jest wolny od zanieczyszczeń innymi syntetykami. To sprawia, że produkty **keeper** oprócz przeszłości, mają zagwarantowane również kolejne życie. **keeper** eco line oszczędza więc zasoby na dwa sposoby – ich produkcja odbywa się w sposób zrównoważony, a dodatkowo wszystkie użyte materiały zostaną ponownie zutylicowane i poddane recyklingowi. I to nie wcześniej niż za 10 lat – dajemy słowo.

keeper eco







Wir handeln so, dass Mensch und Natur auch in Zukunft lebenswerte Bedingungen vorfinden werden. **keeper** Produkte unterstützen von Natur aus eine nachhaltige und bewusste Lebensweise, denn sie werden vor allem für Selbsterbauer, Sammler und Aufbewahrer entwickelt. Die umweltfreundlichen **keeper** Produkte werden in Deutschland design't und in Europa produziert – womit wir die Lieferwege kurz und unseren ökologischen Pfotenabdruck so gering wie möglich halten. Übrigens: Wir verbrauchen bei der Verarbeitung von Thermoplasten bis zu 90 % weniger Energie als beispielsweise bei der Herstellung von Glas oder Keramik benötigt wird.

We act in such a way that people and nature will continue to find liveable conditions in the future. **keeper** products inherently support a sustainable and conscious way of life, because they are primarily developed for do-it-yourselfers, collectors and storekeepers. The environmentally friendly **keeper** products are designed in Germany and produced in Europe - keeping delivery distances short and our ecological pawprint as small as possible. By the way: we use up to 90% less energy in the processing of thermoplastics than is needed in the production of glass or ceramics, for example.

Nous agissons de manière à ce que l'homme et la nature trouvent à l'avenir également des conditions de vie dignes d'être vécues. Les produits **keeper** soutiennent par nature un mode de vie durable et conscient, car ils sont avant tout développés pour les personnes qui font elles-mêmes leurs produits, les collectionneurs et les personnes qui les rangent. Les produits **keeper** respectueux de l'environnement sont conçus en Allemagne et fabriqués en Europe, ce qui nous permet de réduire les distances de livraison et de garantir la qualité des produits. notre empreinte écologique est aussi faible que possible. D'ailleurs, nous utilisons jusqu'à 90% d'énergie en moins pour la transformation des thermoplastiques que pour la fabrication du verre ou de la céramique, par exemple.

Działamy z troską o środowisko w taki sposób, aby w przyszłości zarówno ludzie, jak i zwierzęta mogli znaleźć zdrową i bezpieczną przestrzeń do życia. Produkty marki keeper wspierają naturalnie zrównoważony i świadomy styl życia, ponieważ są głównie przeznaczone dla osób, które samodzielnie tworzą, organizują i przechowują. Przyjazne dla środowiska produkty keeper są projektowane w Niemczech i produkowane w Europie, dzięki czemu odległości dostaw są krótkie, a nasz ślad ekologiczny jest jak najmniejszy. Nawiasem mówiąc: podczas przetwarzania tworzyw termoplastycznych zużywamy do 90% mniej energii niż potrzeba na przykład do produkcji szkła lub ceramiki.

Material: 100% recyclebar

Material: 100% recyclable

Matériau : 100% recyclable

Materiał: w 100% nadający się do recyklingu



Logistik: kurze Lieferwege

Logistics: short delivery routes

Logistique : courtes distances de livraison

Logistyka: krótkie trasy dostaw

Verpackung: FSC zertifiziert

Packaging: FSC certified

Emballage : certifié FSC

Opakowanie: Certyfikat FSC

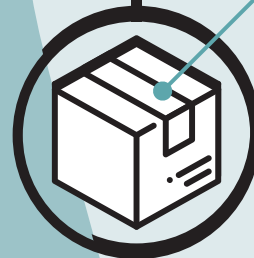

CO₂: geringer Energieverbrauch im Vergleich zu Glas oder Keramik

CO₂: low energy consumption compared to other materials

CO₂: faible consommation d'énergie par rapport à d'autres matériaux

CO₂: niskie zużycie energii w porównaniu z innymi materiałami

Produktion: Reduzierung von Materialverbrauch durch den Einsatz neuester Technologien

Production: use of the latest technologies

Production : utilisation des technologies les plus récentes

Produkcja: Wykorzystanie najnowszych technologii





**10225
eco ben**



profi-klappbox
mit softgriffen 54 x 37 x 28
45 l

folding box
with soft-grips 695 000 00

casier pliant
avec poignées
souples

kosz składany
z miękkimi
uchwytymi

319 000 00



PP*/ 5 120
TPE

695 000 00



*recycled PP



www.blauer-engel.de/uz30a

**11705
mika**



eimer mit ausguss ø 24 x 20
150 000 00

bucket with drain 5 l

seau avec
bec verseur 319 000 00

wiadro z wylewką 695 000 00

150 000 00



PP* 6 450

319 000 00



695 000 00



*recycled PP



www.blauer-engel.de/uz30a

**11710
mika**



eimer mit ausguss ø 30 x 28
150 000 00

bucket with drain 10 l

seau avec
bec verseur 319 000 00

wiadro z wylewką 695 000 00

150 000 00



PP* 6 480

319 000 00



695 000 00



*recycled PP



www.blauer-engel.de/uz30a

keeper



10678
svenja



art.-bezeichnung cm/l
article description cm/l
désignation cm/l
opis produktu cm/l
↔ ↔ ↑

farbe
colour
couleur
kolor

ean13
barcode
ean13
kod kreskowy

mat. mam pal.
mat. moq pal.
mat. moq pal.
mat. min. pal.

bio-küchenabfall-behälter mit schwingdeckel 1,3 l ø 14 x 13

150 000 00



PP* 6 432

bio bin with swing lid

319 000 00



poubelle bio déchets avec swing couvercle

695 000 00



pojemnik bio z obrotową pokrywą



*recycled PP



www.blauer-engel.de/uz30a

11804
elsa



bio-eimer mit deckel oval 13 l 37 x 29,5 x 27,5

150 000 00



PP* 6 192

bio bucket with lid

319 000 00



bio seau avec couvercle

695 000 00



owalne wiadro bio z pokrywą



*recycled PP



www.blauer-engel.de/uz30a

10092
tilda



wanne ergonomisch 30,5 l 57,5 x 38 x 26,5

150 000 00



PP* 5 280

laundry tub ergonomic

319 000 00



baquet à linge ergonomique

695 000 00



ergonomiczna wanna na pranie



*recycled PP



www.blauer-engel.de/uz30a

nach und nach nachhaltiger

Unsere eco Artikel sind langlebig und zu 100 % aus Recycling-Kunststoff.

more sustainable step by step

Our eco items are durable and made from 100% recycled plastic.

de plus en plus durable

Nos articles eco sont durables et fabriqués à 100 % de plastique recyclé.

bardziej zrównoważone środowisko krok po kroku

Nasze produkty ekologiczne są trwałe i wykonane w 100% z plastiku pochodzącego z recyklingu.

100%
recycled
plastic



keeper

art.-bezeichnung
article description
désignation
opis produktu

cm/l
cm/l
cm/l
cm/l



farbe
colour
couleur
kolor

ean13
barcode
ean13
kod kreskowy

mat. mam pal.
mat. moq pal.
mat. moq pal.
mat. min. pal.

10546
emil



dreh-/stapelbox 38 x 28,5 x 20,5
turn around 15 l
stacking box
boîte retournable/
empilable
skrzynka obrotowa

150 000 00
319 000 00
695 000 00



PP* 10 360



*recycled PP



www.blauer-engel.de/uz30a

10188
emil



dreh-/stapelbox 41 x 34,5 x 22
turn around 24 l
stacking box
boîte retournable/
empilable
skrzynka obrotowa

150 000 00
319 000 00
695 000 00



PP* 10 270



*recycled PP



www.blauer-engel.de/uz30a

10516
emil



dreh-/stapelbox 44,5 x 34,5 x 27
turn around 30 l
stacking box
boîte retournable/
empilable
skrzynka obrotowa

150 000 00
319 000 00
695 000 00



PP* 10 220



*recycled PP



www.blauer-engel.de/uz30a

10536
emil



dreh-/stapelbox 54,5 x 39 x 29,5
turn around 45 l
stacking box
boîte retournable/
empilable
skrzynka obrotowa

150 000 00
319 000 00
695 000 00



PP* 10 120



*recycled PP



www.blauer-engel.de/uz30a



im zeichen der umwelt

Gütesiegel kennzeichnen, dass unsere Produkte sicher und langlebig sind. Das Umweltzeichen BLAUER ENGEL zum Beispiel belegt, dass unsere eco line Produkte gleich doppelt ressourcenschonend sind, denn sie werden nicht nur nachhaltig produziert, sondern können auch nachhaltig entsorgt und recycelt werden.

in the service of the environment

Labels indicate that our products are safe and durable. The BLUE ANGEL eco label, for example, attests to the fact that our eco line products are twice as resource-friendly, because they are not only produced sustainably, but can also be disposed of and recycled in a sustainable manner.

sous le signe de l'environnement

Les labels de qualité signalent que nos produits sont sûrs et d'une longue durée de vie. Le label environnemental BLAUER ENGEL, par exemple, atteste que nos produits eco line préservent doublement les ressources, car non seulement ils sont produits de manière durable, mais ils sont également mis au rebut et recyclé de manière durable.

w służbie środowisku

Certyfikaty jakości potwierdzają, że nasze produkty są bezpieczne i trwałe. Na przykład ekologiczne produkty z linii eco, oznaczone symbolem BLUE ANGEL potwierdzają, że w trakcie ich wytwarzania zużywamy dwa razy mniej zasobów, ponieważ nie tylko produkujemy je w zrównoważony sposób, ale również utylizujemy je i poddajemy recyklingowi w sposób przyjazny dla środowiska naturalnego.





natalie

liebt es, sich mal ein
wochenende durch
die freie natur zu boxen.

natalie loves boxing through
nature on a weekend.

natalie aime faire de la boxe en
pleine nature le weekend.

natalie uwielbia weekendowe
spotkania z naturą.

keeper

art.-bezeichnung cm/l
 article description cm/l
 désignation cm/l
 opis produktu cm/l

farbe
 colour
 couleur
 kolor

ean13
 barcode
 ean13
 kod kreskowy

mat. mam pal.
 mat. moq pal.
 mat. moq pal.
 mat. min. pal.

15461
 bruno



euro-box m 35 x 27 x 22
 16 l

150 000 00



PP* 6 96

319 000 00



695 000 00



*recycled PP



www.blauer-engel.de/uz30a

15456
 bruno



euro-box l 43 x 35 x 17,5
 20,5 l

150 000 00



PP* 6 66

319 000 00



695 000 00



*recycled PP



www.blauer-engel.de/uz30a

15453
 bruno



euro-box xl 43 x 35 x 24
 28 l

150 000 00



PP* 6 72

319 000 00



695 000 00



*recycled PP



www.blauer-engel.de/uz30a

15399
 bruno



euro-box xxl 52 x 43 x 28
 54 l

150 000 00



PP* 6 36

319 000 00



695 000 00



*recycled PP



www.blauer-engel.de/uz30a



keeper kitchen



omas gemüseeintopf.

Die besten Rezepte sind die guten alten Familienrezepte. Die wir wahren und hüten wie unser Geheimnis. So auch Omas Gemüseintopf mit all den Köstlichkeiten aus dem Garten. Danach noch ein leckerer Nusskuchen frisch aus dem Ofen und ein selbstgepresster Orangensaft für die Kids.

Selber kochen, aufbewahren oder frischhalten. Alles ist besser als der Coffee-to-go aus dem beschichteten Pappbecher, die Fertiglasagne aus der Aluschale und die viel zu große Portion Spaghetti beim Italiener, die man nicht mal zur Hälfte schafft. Alles zum Kochen, Backen, Einfrieren, Frischhalten, Abwaschen und Transportieren findet ihr bei **keeper**.

grandma's veggie stew.

Old family recipes are the best. Which we store and protect like a secret. For example grandma's veggie stew with all the delicacies from the garden. Followed by a yummy nut cake straight out the oven and a self-pressed orange juice for the kids.

Cooking, storing or keeping it fresh. Anything is better than coffee to go from coated paper cups, ready-made lasagne straight out the aluminium bowl or the way too big portion of spaghetti from your favourite Italian restaurant you cannot even finish half way. Anything for cooking, baking, freezing, keeping food fresh, cleaning and transporting is available here at **keeper**.

la potée de légumes de grand-mère.

Les meilleures recettes sont les bonnes vieilles recettes de famille. Celles que nous gardons et protégeons comme un secret. C'était aussi le cas de la potée de légumes de grand-mère avec tous ses délices du jardin. Suivie encore d'un succulent gâteau à peine sorti du four et un jus d'orange pressé pour les enfants.

Cuisiner, conserver ou maintenir au frais par soi-même. Tout est meilleur que le café à emporter servi dans un gobelet en carton, les lasagnes toutes prêtes du récipient en alu et la portion de spaghettis bien trop grande du restaurant italien dont on laisse plus de la moitié. Vous trouvez ici, chez **keeper**, tout le nécessaire pour la cuisine, la pâtisserie, la congélation, le maintien au frais, le lavage et le transport.

gulasz warzywny babci.

Stare rodzinne przepisy są najlepsze. Takie, które przechowujemy i chronimy jak tajemnicę. Na przykład babciny gulasz przygotowany z warzyw z ogródka, czy pyszne ciasto orzechowe, które zjadamy zanim zdąży ostygnąć. A wszystko to popite własnoręcznie wyciśniętym sokiem z pomarańczy.

Gotowanie, przechowywanie, dbanie o świeżość posiłków. Wszystko co domowe jest lepsze. Lepsze niż kawa z powlekanych kubków, gotowa lasagne z aluminiowej foremki, czy zbyt duża porcja spaghetti w ulubionej włoskiej knajpie, którą znowu zostawisz w połowie. W **keeper** znajdziesz wszystko to, czego potrzebujesz do gotowania, pieczenia, zamrażania, a także utrzymywania świeżości dań czy ich transportu.

keeper kitchen





theo

findet es am tollsten,
wenn papa mit ihm kuchen backt.

theo loves it best when daddy
bakes cakes with him.

theo adore quand papa fait
des gâteaux avec lui.

theo najbardziej lubi,
gdy tata piecze z nim ciasta.



keeper



art.-bezeichnung	cm/l	farbe	ean13	mat.	mam	pal.
article description	cm/l	colour	barcode	mat.	moq	pal.
désignation	cm/l	couleur	ean13	mat.	moq	pal.
opis produktu	cm/l	kolor	kod kreskowy	mat.	min.	pal.

10742
mariella



rührschüssel mit saugnapf 20 x 20 x 13 624 000 00   PP/ 4 192
TPE

mixing bowl with suction cup

bol à mixer antidérapant

miska do miksowania z przysawką



10743
mariella



rührschüssel mit saugnapf 27 x 27 x 15 624 000 00   PP/ 4 96
TPE

mixing bowl with suction cup

bol à mixer antidérapant

miska do miksowania z przysawką



30090
marla



set rührschüssel mit saugnapf + spritzschuttring + teigschaber 20 x 20 x 13 + 27 x 27 x 16 624 000 00   PP/ 3 108
TPE

set of mixing bowls with suction cup + splash guard + dough scraper

set de bols à mixer avec ventouse + couvercle anti-éclaboussures + spatule

zestaw misek do miksowania z przysawką + osłonka + skrobak do ciasta



franca & fabio

frühstücken am liebsten
an der frischen luft.

franca & fabio like to have breakfast
best in the fresh air.

franca & fabio préfèrent prendre
leur petit déjeuner à l'air libre.

franca & fabio śniadanie najlepiej
spożywać na świeżym powietrzu.



keeper

art.-bezeichnung

article description
désignation
opis produktu

cm/l

cm/l
cm/l
cm/l



farbe

colour
couleur
kolor

ean13

barcode
ean13
kod kreskowy

mat. mam pal.

mat. moq pal.
mat. moq pal.
mat. min. pal.

10776 ricardo



tortencontainer
rund 33,5 x 38 x 17 581 000 00

cake container round 680 000 00

boîte pour gâteau
rond

okrągły pojemnik na
ciasto



PP 6 144



10665 enrico



party-butler
rechteckig 43 x 29,5 x 10,5 581 000 00

party-butler
rectangular 680 000 00

party-butler
rectangulaire

pojemnik
„party-butler“
prostokątny



PP 6 240



10664 enrico



party-butler
quadratisch 34,5 x 34,5 x 10,5 581 000 00

party-butler
square 680 000 00

party-butler
au carré

pojemnik
„party-butler“
kwadratowy



PP 6 288



10777 alessio

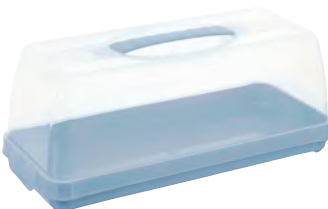

kuchenbehälter 36 x 15 x 15 581 000 00

cake container 680 000 00

boîte pour gâteau

pojemnik na ciasto



PP 12 288



keeper

art.-bezeichnung cm/l
 article description cm/l
 désignation cm/l
 opis produktu cm/l

farbe
 colour
 couleur
 kolor

ean13
 barcode
 ean13
 kod kreskowy

mat. mam pal.
 mat. moq pal.
 mat. moq pal.
 mat. min. pal.



10490
massimo



messkanne mit anti-rutsch-funktion ø 10,5 x 11,5
 0,5 l

130 155 00



PP/TPE 6 4704

measuring jug with anti-slip-function

680 155 00



pichet doseur antidérapant

dżbanek z miarką i funkcją antypoślizgową



10491
massimo



messkanne mit anti-rutsch-funktion ø 13,5 x 14
 1 l

130 155 00



PP/TPE 6 2100

measuring jug with anti-slip-function

680 155 00



pichet doseur antidérapant

dżbanek z miarką i funkcją antypoślizgową



10492
massimo



messkanne mit anti-rutsch-funktion ø 13,5 x 19
 1,5 l

130 155 00



PP/TPE 6 1776

measuring jug with anti-slip-function

680 155 00



pichet doseur antidérapant

dżbanek z miarką i funkcją antypoślizgową



30045
matteo



4
 in 1

set messkanne mit anti-rutsch-funktion und spritzschutzring/ zitruspresse ø 14 x 15
 1 l

130 155 00



PP/TPE 3 444

set measuring jug with anti-slip-function and splash guard/citrus squeezer

680 155 00



set pichet doseur antidérapant avec couvercle anti-éclaboussures et presse-agrumes

antypoślizgowy dżbanek z miarką, osłonka, pokrywka i wyciskacz do cytrusów





10493
mario



art.-bezeichnung cm/l
article description cm/l
désignation cm/l
opis produktu cm/l



farbe
colour
couleur
kolor

ean13
barcode
ean13
kod kreskowy

mat. mam pal.
mat. moq pal.
mat. moq pal.
mat. min. pal.

messbecher ø 8,5 x 11,5
measuring jug 0,25 l
pichet doseur
kubek z miarką

001 155 00



PP 6 11232



10174
carlotta



rührschüssel ø 18 x 14
mit anti-rutsch- funktion 1,5 l

130 000 00

PP/ 6 1728
TPE

mixing bowl
with anti-slip-function

680 000 00



bol à mixer
antidérapant

miska do miksowania
z funkcją
antypoślizgową



10175
carlotta



rührschüssel ø 26 x 14
mit anti-rutsch- funktion 3,5 l

130 000 00

PP/ 6 1440
TPE

mixing bowl
with anti-slip-function

680 000 00



bol à mixer
antidérapant

miska do miksowania
z funkcją
antypoślizgową



30030
camilla



set rührschüssel ø 18 x 14 +
mit anti-rutsch- funktion und ø 27 x 15
spritzschutz/ 1,5 l + 3,5 l
teigschaber

130 000 00

PP/ 3 180
TPE

set mixing bowl with
anti-slip-function
and splash guard/
dough scraper

680 000 00



set de bols à mixer
antidérapants avec
couvercle anti-écla-
boussures/spatule

dwie miski do miksowania
z funkcją antypoślizgową,
osłonką i skrobakiem



molly

mag möhrchen am liebsten,
wenn sie knacken.

molly prefers carrots the most
when they crunch.

molly aime les carottes quand
elles croquent.

molly najbardziej lubi marchewki
za to, że chrupią.



1113
tino



frischhaltedose 14 x 11 x 6,6
food storage box 0,45 l

632 000 00



PP/
tritan 4

1344

boîte fraîcheur

pojemnik
na żywność



tritan line

1114
tino



frischhaltedose 14 x 11 x 9
food storage box 0,7 l

632 000 00



PP/
tritan 4

896

boîte fraîcheur

pojemnik
na żywność



tritan line

keeper

art.-bezeichnung	cm/l	farbe	ean13	mat.	mam	pal.
article description	cm/l	colour	barcode	mat.	moq	pal.
désignation	cm/l	couleur	ean13	mat.	moq	pal.
opis produktu	cm/l	kolor	kod kreskowy	mat.	min.	pal.



1110
tino



frischhaltedose 22,5 x 13,5 x 6,5 632 000 00   PP/ 4 600
food storage box 1 l tritan

boîte fraîcheur

pojemnik
na żywność



1111
tino



frischhaltedose 16 x 16 x 8 632 000 00   PP/ 4 700
food storage box 1,15 l tritan

boîte fraîcheur

pojemnik
na żywność



1112
tino



frischhaltedose 22,5 x 13,5 x 8,2 632 000 00   PP/ 4 400
food storage box 1,35 l tritan

boîte fraîcheur

pojemnik
na żywność



1115
tino



frischhaltedose 16 x 16 x 11,1 632 000 00   PP/ 4 420
food storage box 1,7 l tritan

boîte fraîcheur

pojemnik
na żywność



keeper

art.-bezeichnung	cm/l	farbe	ean13	mat.	mam	pal.
article description	cm/l	colour	barcode	mat.	maq	pal.
désignation	cm/l	couleur	ean13	mat.	maq	pal.
opis produktu	cm/l	kolor	kod kreskowy	mat.	min.	pal.



30689 mia „magic ice“



set 5 x tiefkühl-dose
wiederbeschreibbar,
rechteckig 15,5 x 10,5 x 6
5 x 0,5 l 680 286 00



PP 6 912

set 5 x food container
rewritable, rectangular

set 5 x boîte alimentaire
de conservation,
réinscriptible



zestaw 5 pojemników na
żywność z etykietą
wielokrotnego zapisu



30690 mia „magic ice“



set 4 x tiefkühl-dose
wiederbeschreibbar,
rechteckig 15,5 x 10,5 x 8,5
4 x 0,75 l 680 286 00



PP 6 900

set 4 x food container
rewritable, rectangular

set 4 x boîte alimentaire
de conservation,
réinscriptible



zestaw 4 pojemników na
żywność z etykietą
wielokrotnego zapisu



30691 mia „magic ice“



set 3 x tiefkühl-dose
wiederbeschreibbar,
rechteckig 15,5 x 10,5 x 11,5
3 x 1 l 680 286 00



PP 6 660

set 3 x food container
rewritable, rectangular

set 3 x boîte alimentaire
de conservation,
réinscriptible



zestaw 3 pojemników na
żywność z etykietą
wielokrotnego zapisu



30052 mia „magic ice“



set 3 x tiefkühl-dose
wiederbeschreibbar,
rechteckig 20,5 x 15,5 x 6,5
3 x 1,25 l 680 286 00



PP 6 624

set 3 x food container
rewritable, rectangular

set 3 x boîte alimentaire
de conservation,
réinscriptible



zestaw 3 pojemników na
żywność z etykietą
wielokrotnego zapisu





art.-bezeichnung cm/l
 article description cm/l
 désignation cm/l
 opis produktu cm/l

farbe
 colour
 couleur
 kolor

ean13
 barcode
 ean13
 kod kreskowy

mat. mam pal.
 mat. moq pal.
 mat. moq pal.
 mat. min. pal.



30692

mia „magic ice“

set 2 x tiefkühl-dose 20,5 x 15,5 x 10,5 680 286 00
 wiederbeschreibbar,
 rechteckig 2 x 2 l



PP 6 528



set 2 x food container
 rewritable, rectangular

set 2 x boîte alimentaire
 de conservation,
 réinscriptible



zestaw 2 pojemników na
 żywność z etykietą
 wielokrotnego zapisu



lena

hat ein faible für die
 farben der saison.

lena has a soft spot for the
 colors of the season.

lena a un faible pour les
 couleurs de la saison.

lena ma słabość do
 sezonowych kolorów.

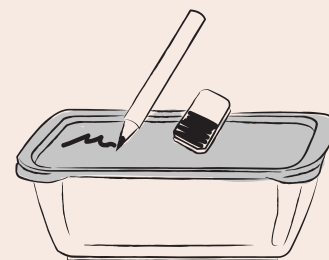

mia

merkt sich einfach alles,
 denn ihr Deckel ist ganz
 einfach beschreibbar. Und
 wieder-weg-radierbar. Und
 wieder beschreibbar. Und
 wieder ...

mia remembers anything easily
 because her lid is writeable -
 and erasable. And re-writeable.
 And again erasable ...

mia se souvient simplement de tout,
 car il est facile d'écrire sur son couvercle.
 Et d'effacer. Et de réécrire. Et de ...

mia pamięta wszystko dzięki swojej
 pokrywce, na której można wszystko
 zapisać... i wymazać.
 A potem napisać jeszcze raz.
 I jeszcze raz ...

keeper

art.-bezeichnung	cm/l	farbe	ean13	mat.	mam	pal.
article description	cm/l	colour	barcode	mat.	maq	pal.
désignation	cm/l	couleur	ean13	mat.	maq	pal.
opis produktu	cm/l	kolor	kod kreskowy	mat.	min.	pal.



30672 fredo fresh



set 5 x
frischhaltedose,
rechteckig 15,5 x 10,5 x 6 632 000 00
5 x 0,5 l



PP 6 912

set 5 x food storage box,
rectangular

set 5 x boîte alimentaire
de conservation,
rectangulaire

zestaw
5 pojemników
na żywność



30673 fredo fresh



set 4 x
frischhaltedose,
rechteckig 15,5 x 10,5 x 8,5 632 000 00
4 x 0,75 l



PP 6 900

set 4 x food storage box,
rectangular

set 4 x boîte alimentaire
de conservation,
rectangulaire

zestaw
4 pojemników
na żywność



30674 fredo fresh



set 3 x
frischhaltedose,
rechteckig 15,5 x 10,5 x 11,5 632 000 00
3 x 1 l



PP 6 660

set 3 x food storage box,
rectangular

set 3 x boîte alimentaire
de conservation,
rectangulaire

zestaw
3 pojemników
na żywność



30675 fredo fresh



set 3 x
frischhaltedose,
rechteckig 20,5 x 15,5 x 6,5 632 000 00
3 x 1,25 l



PP 6 624

set 3 x food storage box,
rectangular

set 3 x boîte alimentaire
de conservation,
rectangulaire

zestaw
3 pojemników
na żywność





art.-bezeichnung	cm/l	farbe	ean13	mat.	mam	pal.
article description	cm/l	colour	barcode	mat.	moq	pal.
désignation	cm/l	couleur	ean13	mat.	moq	pal.
opis produktu	cm/l	kolor	kod kreskowy	mat.	min.	pal.



30676 fredo fresh



set 2 x
frischhaltedose,
rechteckig
20,5 x 15,5 x 10,5
2 x 2 l
632 000 00



PP 6 528

set 2 x food storage box,
rectangular

set 2 x boîte alimentaire
de conservation,
rectangulaire

zestaw
2 pojemników
na żywność



30679 fredo fresh



set 3 x
frischhaltedose,
rechteckig
29 x 19 x 7
3 x 2,4 l
632 000 00



PP 6 252

set 3 x food storage box,
rectangular

set 3 x boîte alimentaire
de conservation,
rectangulaire

zestaw
3 pojemników
na żywność



30680 fredo fresh



set 2 x
frischhaltedose,
rechteckig
29 x 19 x 9
2 x 3,3 l
632 000 00



PP 6 252

set 2 x food storage box,
rectangular

set 2 x boîte alimentaire
de conservation,
rectangulaire

zestaw
2 pojemników
na żywność

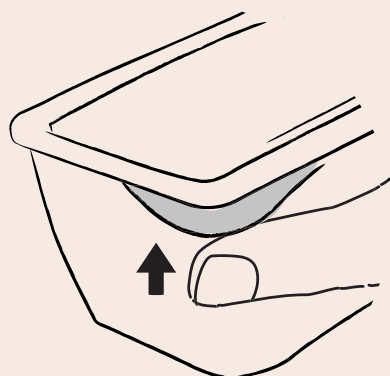

der fredo mit der ecke

Ganz einfach zu öffnen oder schließen, dank des Deckels mit Eck-Lasche.

fredo with the corner
Very easy to open or
close, thanks to the lid
with corner tab.

le fredo avec le coin
Très facile à ouvrir ou à
fermer, grâce au cou-
vercle avec languette
d'angle.

fredo z narożną zakładką
Bardzo łatwo otwiera się i
zamyka, dzięki wyprofilo-
wanej pokrywce.

keeper

art.-bezeichnung cm/l
 article description cm/l
 désignation cm/l
 opis produktu cm/l

↔ ↕

farbe
 colour
 couleur
 kolor

ean13
 barcode
 ean13
 kod kreskowy

mat. mam pal.
 mat. moq pal.
 mat. moq pal.
 mat. min. pal.

10694
 carla „space tour“



deco-click-box mini 17 x 13 x 3,5
 0,5 l

680 284 00



PP 10 2100



10697
 carla „space tour“



deco-click-box midi 17 x 13 x 7
 1 l

680 284 00



PP 10 1020



10694
 carla „sweet day“



deco-click-box mini 17 x 13 x 3,5
 0,5 l

581 283 00



PP 10 2100



10697
 carla „sweet day“



deco-click-box midi 17 x 13 x 7
 1 l

581 283 00



PP 10 1020



10694
 carla „sandwich“



deco-click-box mini 17 x 13 x 3,5
 0,5 l













315 282 00



PP 10 2100





	art.-bezeichnung article description désignation opis produktu	cm/l cm/l cm/l cm/l	farbe colour couleur kolor	ean13 barcode ean13 kod kreskowy	mat. mat. mat.	mam moq min.	pal. pal. pal.
10691 luca	click-box micro	11 x 7,5 x 6 0,35 l	315 000 00 581 000 00 680 000 00	 4 052396 081305  4 052396 081312  4 052396 081329	PP	10	3000
10692 luca	click-box mini	17 x 13 x 3,5 0,5 l	315 000 00 581 000 00 680 000 00	 4 052396 081336  4 052396 081343  4 052396 081350	PP	10	2100
10693 luca	click-box midi	17 x 13 x 7 1 l	315 000 00 581 000 00 680 000 00	 4 052396 081367  4 052396 081374  4 052396 081381	PP	10	1020
10695 luca	click-box maxi	30 x 20 x 8,5 3,7 l	315 000 00 581 000 00 680 000 00	 4 052396 081398  4 052396 081411  4 052396 081428	PP	5	300
10697 carla „sandwich“	deco-click-box midi	17 x 13 x 7 1 l	315 282 00	 4 052396 081466	PP	10	1020



keeper

art.-bezeichnung
 article description
 désignation
 opis produktu

cm/l
 cm/l
 cm/l
 cm/l



farbe
 colour
 couleur
 kolor

ean13
 barcode
 ean13
 kod kreskowy

mat. mam pal.
 mat. moq pal.
 mat. moq pal.
 mat. min. pal.

10162
pablo



besteckkasten
 geschlossen
 5 fächer

33,5 x 26,5 x 5

001 000 00



PP 10 670

cutlery box
 5 compartments

130 000 00



range couverts
 5 compartiments

pojemnik na sztućce
 5 przegródek



10163
pablo



besteckkasten
 geschlossen
 7 fächer

39,5 x 37 x 5

001 000 00



PP 10 450

cutlery box
 7 compartments

130 000 00



range couverts
 7 compartiments

pojemnik na sztućce
 7 przegródek



10451
franca



besteckkasten
 ausziehbar,
 passt sich der gröÙe
 der schublade an

38 x 32 x 7,5

100 000 00



PP 6 108

cutlery box adjustable,
 adapts to suit the size
 of the drawer

range couverts extensible,
 s'adapte à la taille du tiroir

pojemnik na sztućce
 regulowany do
 wielkości szuflady



10462
filippa



besteckkasten
 mit schieber
 13 fächer

38 x 42,5 x 7,5

100 000 00



PP 6 108

cutlery box
 with slider
 13 compartments

range couverts
 13 compartiments
 avec élément
 coulissant

pojemnik na sztućce
 z przesuwaną wkładką
 13 przegródek





14498
ivo

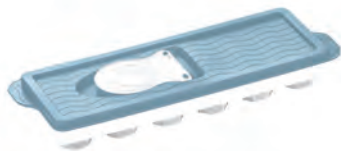

art.-bezeichnung cm/l
article description cm/l
désignation cm/l
opis produktu cm/l



farbe
colour
couleur
kolor

ean13
barcode
ean13
kod kreskowy

mat. mam pal.
mat. moq pal.
mat. moq pal.
mat. min. pal.

eiswürfelbehälter mit deckel 9,5 x 26,5 x 4

680 000 00



PP/ 12 1176
PE

ice cube tray with cover

bac à glaçons avec couvercle

foremka na kostki lodu z pokrywką



10312
milan



küchenabfalleimer zum einhängen 16 x 27 x 19
41

130 000 00



PP 4 320

hanging waste bin

poubelle suspendue

kosz na śmieci do zawieszania

10468
fabrizio



keep-fresh-container ø 37 x 15
7,5 l

100 000 00



PP 6 192

pojemnik na ciasto



10469
bella



mikrowellen-abdeckhaube ø 26,5

001 000 00



PP 12 1152

microwave cover

couvre assiettes micro-ondes

pokrywa do kuchenki mikrofalowej



liam

ist heute noch tellerwäscher
und später vielleicht mal chef.

liam is a dishwasher today,
but one day, he might be a chef.

liam est encore plongeur
et peut-être un jour, chef.

liam dziś pomaga w myciu naczyń,
ale pewnego dnia zostanie szefem
kuchni.



10585 pierre



geschirrablaufkorb 39,5 x 29,5 x 8
mit tablett small

001 000 00



PP 6 162

dish-drainer basket
with tray small

130 000 00



petit égouttoir
à vaisselle
avec plateau

odsączarka do
naczyni z tacą małą



10586 pierre



geschirrablaufkorb 39,5 x 39,5 x 8
mit tablett large

001 000 00



PP 6 252

dish-drainer basket
with tray large

130 000 00



grand égouttoir
à vaisselle
avec plateau

odsączarka do
naczyni z tacą duża



10581 pino



besteckabtropfer 16 x 16 x 12

130 000 00



PP 5 2660

cutlery drainer

égouttoir à couverts

ociekacz
na sztućce



keeper

art.-bezeichnung cm/l
article description cm/l
désignation cm/l
opis produktu cm/l
 ↕ ↔ ↕

farbe
colour
couleur
kolor

ean13
barcode
ean13
kod kreskowy

mat. **mam** **pal.**
mat. **moq** **pal.**
mat. **min.** **pal.**



10527
stella



schüssel-sieb 2in1 klein 21 x 21 x 10,5
 bowl colander 2in1 small
 bol-passoire 2en1 petit
 miska-cedzak 2w1 mała

130 000 00



PP 8 360

680 000 00



10528
stella



schüssel-sieb 2in1 groß 25 x 25 x 12
 bowl colander 2in1 large
 bol-passoire 2en1 grand
 miska-cedzak 2w1 duża

130 000 00



PP 6 288

680 000 00



10530
fabio



stielseiher ø 24 x 11
 colander with grip
 passoire avec manche
 cedzak z uchwytem

001 000 00



PP 10 960

130 000 00



10532
fabienne



seiher ø 26 x 11
 colander
 passoire
 cedzak

001 000 00



PP 10 2400

130 000 00



keeper

art.-bezeichnung	cm/l	farbe	ean13	mat.	mam	pal.
article description	cm/l	colour	barcode	mat.	moq	pal.
désignation	cm/l	couleur	ean13	mat.	moq	pal.
opis produktu	cm/l	kolor	kod kreskowy	mat.	min.	pal.



10481
paola



schüttdose	6,5 x 4 x 12	100 000 00		PE/ SAN	10	1920
pouring jar	0,25 l					
boîte à bec verseur						
pojemnik do produktów sypkich						



10484
paola



schüttdose	8 x 4,5 x 15	100 000 00		PE/ PS	10	1120
pouring jar	0,5 l					
boîte à bec verseur						
pojemnik do produktów sypkich						



10482
paola



schüttdose	10,5 x 5,5 x 17	100 000 00		PE/ PS	10	640
pouring jar	0,75 l					
boîte à bec verseur						
pojemnik do produktów sypkich						



10485
paola



schüttdose	11 x 6,5 x 19	100 000 00		PE/ PS	10	560
pouring jar	1 l					
boîte à bec verseur						
pojemnik do produktów sypkich						



10483
paola



schüttdose	11,5 x 7 x 21	100 000 00		PE/ PS	10	480
pouring jar	1,5 l					
boîte à bec verseur						
pojemnik do produktów sypkich						



silvie

sichert sich die süßesten früchte.

silvie secures herself the sweetest fruit.

silvie cueille les meilleurs fruits.

silvie zostawiła najśodsze
owoce dla siebie.

47



10418
jean



cerealien-box 21,5 x 9,5 x 24 130 000 00

cereal-dispenser 2,6 l

boîte à céréales

pojemnik na płatki
śniadaniowe



PP/ 4 280
PE

10419
jean



cerealien-box 24 x 11,5 x 30,5 130 000 00

cereal-dispenser 5 l

boîte à céréales

pojemnik na płatki
śniadaniowe



PP/ 4 200
PE

keeper

art.-bezeichnung cm/l
 article description cm/l
 désignation cm/l
 opis produktu cm/l

farbe
 colour
 couleur
 kolor

ean13
 barcode
 ean13
 kod kreskowy

mat. mam pal.
 mat. moq pal.
 mat. moq pal.
 mat. min. pal.



10991
pepe



ordnungssystem 8 x 8 x 5
 organizing system
 système de rangement modulaire
 system porządkowy

160 000 00



PP* 12 6552



*recycled PP

10992
pepe



ordnungssystem 15 x 8 x 5
 organizing system
 système de rangement modulaire
 system porządkowy

160 000 00



PP* 12 3640



*recycled PP

10993
pepe



ordnungssystem 23 x 8 x 5
 organizing system
 système de rangement modulaire
 system porządkowy

160 000 00



PP* 12 2444



*recycled PP

10994
pepe



ordnungssystem 30 x 8 x 5
 organizing system
 système de rangement modulaire
 system porządkowy

160 000 00



PP* 12 1700



*recycled PP

10995
pepe



ordnungssystem 38 x 8 x 5
 organizing system
 système de rangement modulaire
 system porządkowy

160 000 00



PP* 12 1456



*recycled PP



pepe packt's an ...

... und sorgt in jeder schublade ganz flexibel für ordnung.

pepe tackles it and keeps every drawer tidy in a very flexible way.

pepe s'y met en mettant de l'ordre dans chaque tiroir de manière très flexible.

pepe radzi sobie z każdą szufladą utrzymując w niej porządek w bardzo elastyczny sposób.

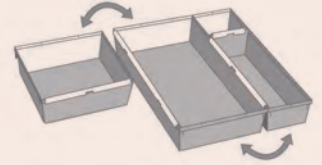

10996
pepe



ordnungssystem 15 x 15 x 5
organizing system
système de rangement modulaire
system porządkowy

160 000 00



PP* 12 1820



*recycled PP

10997
pepe



ordnungssystem 23 x 15 x 5
organizing system
système de rangement modulaire
system porządkowy

160 000 00



PP* 12 1248



*recycled PP

10998
pepe



ordnungssystem 30 x 15 x 5
organizing system
système de rangement modulaire
system porządkowy

160 000 00



PP* 12 850



*recycled PP

10999
pepe



ordnungssystem 38 x 15 x 5
organizing system
système de rangement modulaire
system porządkowy

160 000 00



PP* 12 742



*recycled PP

keeper home



das bisschen haushalt.

Zuhause ist es immer noch am schönsten! Oder immer wieder? Eben immer dann, wenn es nach getaner Arbeit wieder überall blitzt und blinkt. Dafür gibt es von **keeper** ein paar echte Haushaltshilfen, die euch tatkräftig zur Hand gehen – beim Putzen und beim Wischen. Bei der Wäsche und bei der Müllsortierung. Damit macht sich der Haushalt zwar auch noch nicht von allein, aber deutlich mehr Freude!

a little bit of housekeeping.

Home is wherever the heart is! Or ever again? Whenever everything is shining after the cleaning is done. For that, **keeper** has a few real household helpers that make life easier for you – in cleaning and wiping. For laundry and waste sorting. Housekeeping still does not take care of itself then, but it is much more fun at least!

un peu de ménage.

C'est toujours plus beau à la maison ! Ou de nouveau plus beau ? A chaque fois que tout à retrouvé son éclat, une fois le travail achevé. **keeper** propose quelques véritables aides domestiques qui vous donnent un fort coup de main pour l'essuyage et le nettoyage. La lessive et le tri des déchets. Certes, même avec ces aides, le ménage ne se fait pas tout seul, mais on y prend plus de plaisir !

małe domowe porządki.

Dom twój, gdzie serce twoje! Ale czy zawsze? Na pewno wtedy, kiedy wszystko lśni czystością. Domowi pomocnicy **keeper** ułatwią nieco to zadanie - pomogą przy sprzątnięciu, praniu, układaniu czy sortowaniu odpadów. Co prawda, nie zrobią wszystkiego za nas sami, ale z pewnością sprawią, że wszystko stanie się choć trochę przyjemniejsze!

A woman with curly hair is sitting in a chair, looking at a large green plant. The text "keeper home" is overlaid on the image.

keeper home



marie

liebt frische luft und frische farben.

marie loves fresh air and fresh colours.

marie aime l'air frais et les couleurs fraîches.

marie uwielbia świeże powietrze i świeże kolory



ob loft oder landhaus

Schrank oder Schreibtisch: lotta ist ein echter Allrounder. Sie ist sowohl elegant als auch hart im Nehmen – dank ihrer kratzfesten und dekorativen Oberfläche. Man kann sie platzsparend ineinander stellen oder auch, um neunzig Grad gedreht, aufeinander stapeln. Ganz so, wie es euch gefällt! (Und wenn ihr mal vom Loft ins Landhaus zieht, erleichtern euch lottas Griffe sogar den Transport.)

Whether it is in the loft or country house, cupboard or desk: lotta is a real all-rounder. She is both elegant and very tough thanks to her scratch-resistant and decorative surface. You can stack the boxes into each other to save space or even on top of each other by turning them by ninety degrees. Anyway you like! (lotta's handles even make it easier to carry her from the loft into the country house.)

Loft ou maison de campagne, armoire ou bureau : lotta est multifonctionnel ! Elle est à la fois élégante et résistante à toutes épreuves grâce à sa surface anti-rayures et décorative. Vous pouvez les emboîter pour économiser de la place, les incliner à 90°, les empiler. Comme il vous plaira ! (Et pendant un transfert du loft à la maison de campagne, les poignées de lotta vous faciliteront le transport.)

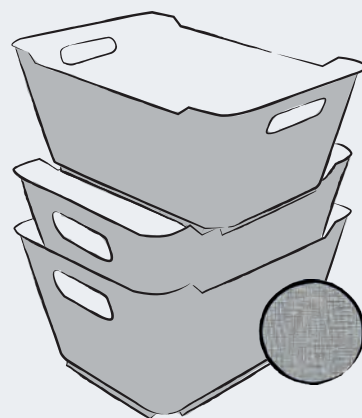

Czy to na poddaszu, czy na działce, w szafce czy na biurku: lotta jest naprawdę wszechstronna! To pudełko jest eleganckie i bardzo wytrzymałe dzięki swojej odpornej na zarysowania i dekoracyjnej powierzchni. Możesz układać pojemniki jeden w drugi, aby zaoszczędzić miejsce, a nawet postawić jeden na drugim, obracając je o 90 stopni. Jak tylko chcesz! (uchwyty dodatkowo ułatwiają przenoszenie lotty np. z poddasza na działkę.)

keeper

art.-bezeichnung
article description
désignation
opis produktu

cm/l
cm/l
cm/l
↕ ↔ ↕

farbe
colour
couleur
kolor

ean13
barcode
ean13
kod kreskowy

mat. mam pal.
mat. moq pal.
mat. min. pal.



10910
lotta



lifestyle-box

19,5 x 14 x 10
1,8 l



001 000 00



PP 6 4608

827 000 00



PP

130 000 00



recycled PP*

581 000 00



recycled PP*

680 000 00



recycled PP*

10911
lotta



lifestyle-box

29,5 x 19 x 15
6 l



001 000 00



PP 6 2100

827 000 00



PP

130 000 00



recycled PP*

581 000 00



recycled PP*

680 000 00



recycled PP*

10912
lotta



lifestyle-box

35,5 x 23,5 x 20
12 l



001 000 00



PP 6 900

827 000 00



PP

130 000 00



recycled PP*

581 000 00



recycled PP*

680 000 00



recycled PP*

10913
lotta



lifestyle-box

40 x 28 x 25
20 l



001 000 00



PP 6 640

827 000 00



PP

130 000 00



recycled PP*

581 000 00



recycled PP*

680 000 00



recycled PP*

keeper

art.-bezeichnung cm/l
article description cm/l
désignation cm/l
opis produktu cm/l



farbe
colour
couleur
kolor

ean13
barcode
ean13
kod kreskowy

mat. mam pal.
mat. moq pal.
mat. moq pal.
mat. min. pal.

11136
stine



aufbewahrungskorb 23,5 x 17 x 12

130 000 00



PP 6 630

storage basket 3,5 l

680 000 00



panier de rangement

koszyk do przechowywania



11137
stine



aufbewahrungskorb 27 x 21,5 x 15

130 000 00



PP 6 504

storage basket 6 l

680 000 00



panier de rangement

koszyk do przechowywania



11138
stine



aufbewahrungskorb 38 x 28,5 x 15

130 000 00



PP 6 240

storage basket 12 l

680 000 00



panier de rangement

koszyk do przechowywania



11139
stine

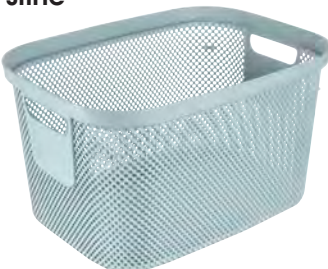

aufbewahrungskorb 38 x 28,5 x 22,5

130 000 00



PP 6 192

storage basket 18 l

680 000 00



panier de rangement

koszyk do przechowywania



franzi

liebt es die wäsche an der frischen luft zu trocknen.

franzi loves drying fresh laundry in a fresh breeze.

franzi aime sécher le linge à l'air frais.

franzi uwielbia suszyć pranie na świeżym powietrzu.

57



11148
bosse



wäschekorb	53 x 34,5 x 22,5	130 000 00			PP	5	120
laundry basket	30 l			4 052396 099669			
corbelle à linge		680 000 00					
kosz na pranie				4 052396 099676			



11149
arne



wäschebox	47,5 x 36 x 57,5	130 000 00			PP	4	48
laundry hamper	58 l			4 052396 099683			
coffre à linge		680 000 00					
kosz na bieliznę				4 052396 099690			



keeper

art.-bezeichnung	cm/l	farbe	ean13	mat.	mam	pal.
article description	cm/l	colour	barcode	mat.	maq	pal.
désignation	cm/l	couleur	ean13	mat.	maq	pal.
opis produktu	cm/l	kolor	kod kreskowy	mat.	min.	pal.



10782
lasse



wäschekorb
ergonomisch
mit softgriffen

laundry basket
ergonomic
with soft-grips

corbelle à linge
ergonomique
avec poignées
souples

ergonomiczny
kosz na pranie
z miękkimi uchwytami

130 000 00



PP*/ 5 100
TPE

581 000 00



PP*/
TPE

680 000 00



PP*/
TPE



*recycled PP

10783
janne



wanne
ergonomisch
mit softgriffen

laundry tub
ergonomic
with soft-grips

baquet à linge
ergonomique avec
poignées souples

ergonomiczna
wanna na pranie
z miękkimi uchwytami

130 000 00



PP*/ 5 100
TPE

581 000 00



PP*/
TPE

680 000 00



PP*/
TPE



*recycled PP

super soft mit perfekten rundungen

janne macht einfach eine gute Figur! Die ergonomische Wäschewanne im modernen Design lässt sich mit wenig Kraftaufwand tragen, da ihre Form eurer Form angepasst ist. Anschmiegsam sind auch die Softgriffe mit Anti-Rutsch-Flächen, die für zusätzlichen Tragekomfort sorgen. Hochgehoben – losgewaschen!

Super soft with curves in all the right places – janne simply has a good figure! The ergonomic laundry tub in a modern design requires little effort to carry as its shape adapts to yours. The soft grips with anti-slip surfaces are also pleasant to the touch and ensure extra carrying comfort. Lift up and wash away!

Dotée d'une parfaite souplesse et de belles rondeurs, janne est tout simplement bien foutue. Avec sa forme ergonomique et son design moderne, vous pourrez l'emporter facilement d'une pièce à l'autre sans vous casser le dos. Ses poignées souples et antidérapantes vous garantiront, quant à elles, plus de confort. Si tôt empoigné, si tôt lavé!

Super miękka o perfekcyjnych zaokrągleniach - janne po prostu dobrze się prezentuje! Ergonomiczna wanna na pranie modnie zaprojektowana daje się nosić bez większego wysiłku, bo jej kształt jest dopasowany do waszej sylwetki. Miękkie są też jej uchwyty o powierzchni antypoślizgowej, zwiększające komfort noszenia. Tylko podnieść i zaczynać pranie!

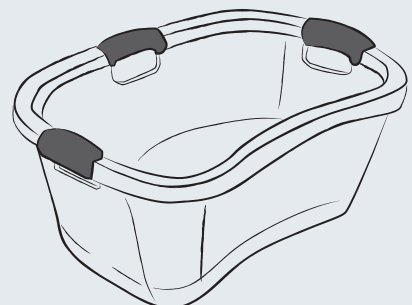

lilja

liebt es, mit ihren kindern
lautstark zu lachen.

lilja loves to laugh out loud
with her children.

lilja aime rire fort avec
ses enfants.

lilja uwielbia głośno śmiać
się ze swoimi dziećmi.



keeper

art.-bezeichnung
article description
désignation
opis produktu

cm/l
cm/l
cm/l
cm/l



farbe
colour
couleur
kolor

ean13
barcode
ean13
kod kreskowy

mat. mam pal.
mat. moq pal.
mat. moq pal.
mat. min. pal.

10092
tilda



wanne
ergonomisch

57,5 x 38 x 26,5
30,5 l

130 000 00



PP 5 280

laundry tub
ergonomic

581 000 00



baquet à linge
ergonomique

680 000 00



ergonomiczna
wanna na pranie



10093
anton



wäschekorb
ergonomisch

57,5 x 38 x 26,5
30,5 l

130 000 00



PP 5 280

laundry basket
ergonomic

581 000 00



corbelle à linge
ergonomique

680 000 00



ergonomiczny
kosz na pranie



sina & sonja





















haben immer viel spaß,
wenn wieder waschtag ist.

sina & sonja always have a lot of fun
when it's washing day again.

sina & sonja s'amuse toujours beaucoup
quand c'est à nouveau le jour de la lessive

sina i sonja zawsze świetnie się bawią,
gdy nadchodzi dzień prania.



	art.-bezeichnung article description désignation opis produktu	cm/l cm/l cm/l cm/l ↕ ↔ ↕	farbe colour couleur kolor	ean13 barcode ean13 kod kreskowy	mat. mat. mat.	mam moq min.	pal. pal. pal.
10780 jost 	wäschekorb	55 x 40 x 23	130 000 00	 4 052396 082197	PP	5	180
	laundry basket	32 l					
	corbeille à linge		581 000 00	 4 052396 082203			
	kosz na pranie		680 000 00	 4 052396 082210			
10781 jost 	wäschekorb	65 x 44 x 28	130 000 00	 4 052396 082227	PP	5	90
	laundry basket	52 l					
	corbeille à linge		581 000 00	 4 052396 082234			
	kosz na pranie		680 000 00	 4 052396 082241			
10785 aenna 	wanne	55 x 40 x 23	130 000 00	 4 052396 082258	PP	5	180
	laundry tub	32 l					
	baquet		581 000 00	 4 052396 082265			
	wanna na pranie		680 000 00	 4 052396 082272			
10786 aenna 	wanne	65 x 44 x 28	130 000 00	 4 052396 082289	PP	5	90
	laundry tub	52 l					
	baquet		581 000 00	 4 052396 082296			
	wanna na pranie		680 000 00	 4 052396 082302			
10701 per 	wäschebox	45 x 34 x 60	130 000 00	 4 052396 082319	PP	4	120
	laundry hamper	60 l					
	coffre à linge		581 000 00	 4 052396 082326			
	kosz do bielizny		680 000 00	 4 052396 082333			

keeper

art.-bezeichnung	cm/l	farbe	ean13	mat.	mam	pal.
article description	cm/l	colour	barcode	mat.	moq	pal.
désignation	cm/l	couleur	ean13	mat.	moq	pal.
opis produktu	cm/l	kolor	kod kreskowy	mat.	min.	pal.



10301
tjark



treteimer	19,5 x 20,5 x 20,5	130 000 00			PP	6	126
pedal dustbin	3 l			4 052396 091359			
poubelle à pédale		519 000 00					
				4 052396 091366			



10302
tjark



treteimer	22,5 x 24 x 26	130 000 00			PP	6	72
pedal dustbin	5,5 l			4 052396 091373			
poubelle à pédale		519 000 00					
				4 052396 091380			



10303
tjark



treteimer	27,5 x 29 x 32,5	130 000 00			PP	6	36
pedal dustbin	11,5 l			4 052396 091397			
poubelle à pédale		519 000 00					
				4 052396 091403			



10304
tjark



treteimer	33,5 x 34,5 x 39	130 000 00			PP	4	16
pedal dustbin	21 l			4 052396 091410			
poubelle à pédale		519 000 00					
				4 052396 091427			





svea

genießt es, stressfrei in
den sonntag zu starten.

svea enjoys a stress-free start
to sunday.

svea apprécie de commencer
son dimanche sans stress.

svea cieszy się bezstresowym
rozpoczęciem niedzieli.



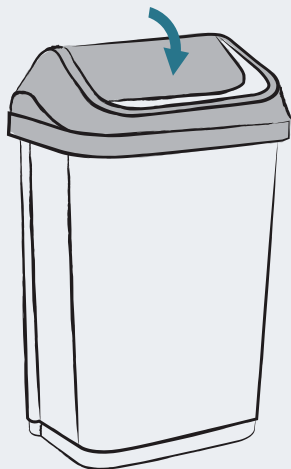

it's swing time, baby!

swantjes Schwingdeckel swingt ganz so, wie ihr es bei der täglichen Müllentsorgung am liebsten habt. Abnehmbar ist er übrigens auch. Da ist Musik drin!

It's swing time, baby!
swantje's swing lid swings in just the right way when you throw things out. By the way, it's also removable. That's a bonus!

It's swing time, baby!
Le couvercle oscillant de swantje swingue au rythme que vous lui donnez lors de l'usage quotidien. Et en plus, il est amovible. Cette poubelle mettra de l'ambiance dans votre cuisine!

It's swing time, baby!
Obrotowa pokrywa swantje odchyła się w odpowiedni sposób, gdy coś wyrzucasz. Nawiasem mówiąc, można ją również wyciągnąć. To niebywała zaleta!

10306 swantje



abfallbehälter mit schwingdeckel 25,5 x 19 x 38 160 000 00

waste bin with swing lid 10 l 315 000 00

poubelle avec couvercle swing 680 000 00

kosz na śmieci z obrotową pokrywą

160 000 00



PP* 6 324

315 000 00



PP*

680 000 00



PP*



*recycled PP

10307 swantje



abfallbehälter mit schwingdeckel 33,5 x 25,5 x 53,5 160 000 00

waste bin with swing lid 25 l 315 000 00

poubelle avec couvercle swing 680 000 00

kosz na śmieci z obrotową pokrywą

160 000 00



PP* 5 110

315 000 00



PP*

680 000 00



PP*



*recycled PP

10308 swantje



abfallbehälter mit schwingdeckel 38,5 x 29 x 66 160 000 00

waste bin with swing lid 50 l 315 000 00

poubelle avec couvercle swing 680 000 00

kosz na śmieci z obrotową pokrywą

160 000 00



PP* 4 80

315 000 00



PP*

680 000 00



PP*



*recycled PP

keeper

art.-bezeichnung
article description
désignation
opis produktu

cm/l
cm/l
cm/l

farbe
colour
couleur
kolor

ean13
barcode
ean13
kod kreskowy

mat. mam pal.
mat. moq pal.
mat. moq pal.
mat. min. pal.

65



10453
rasmus



abfallbehälter
mit rolldeckel

25,5 x 19 x 39
10 l

160 000 00



PP* 6 324

waste bin
with roll lid

315 000 00



PP*

poubelle avec
couvercle roll

680 000 00



PP*

kosz na śmieci
z odchylaną
pokrywą



*recycled PP

10454
rasmus



abfallbehälter
mit rolldeckel

34 x 26 x 54
25 l

160 000 00



PP* 5 110

waste bin
with roll lid

315 000 00



PP*

poubelle avec
couvercle roll

680 000 00



PP*

kosz na śmieci
z odchylaną
pokrywą



*recycled PP

10455
rasmus



abfallbehälter
mit rolldeckel

39 x 29,5 x 67,5
50 l

160 000 00



PP* 4 80

waste bin
with roll lid

315 000 00



PP*

poubelle avec
couvercle roll

680 000 00



PP*

kosz na śmieci
z odchylaną
pokrywą



*recycled PP

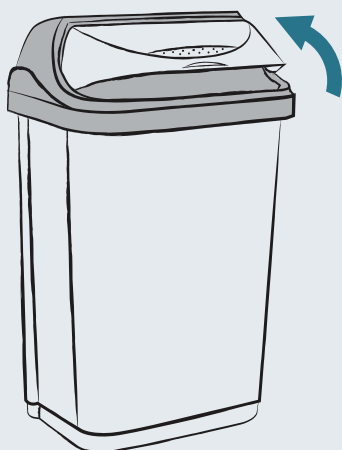

let the good times roll!

rasmus' Deckel rollt mindestens genauso schön wie das „r“ in seinem Namen. rrrrrasmus. Für alles, das raus muss.

let the good times roll!
rasmus' lid rolls just as perfectly as the „r“ in his name. rrrrrasmus. For anything that goes around.

Payons-nous du bon temps...
en roulant ! Le couvercle de rasmus roule au moins aussi bien que le « r » de son nom. rrrrrasmus. Pour tout ce qui doit partir.

let the good times roll!
Pokrywa rasmus'a odchyła się tak samo perrrrfekcyjnie jak „r“ w jego imieniu. rrrrrasmus. Dobry na wszystko.

keeper

art.-bezeichnung
article description
désignation
opis produktu

cm/l
cm/l
cm/l
cm/l
↕ ↔ ↗

farbe
colour
couleur
kolor

ean13
barcode
ean13
kod kreskowy

mat. mam pal.
mat. moq pal.
mat. moq pal.
mat. min. pal.

10603
magne



abfallbehälter
mit flip-deckel

29,5 x 18 x 36,5
10 l

160 000 00



PP*/ 6 192
TPE

waste bin
with flip lid

315 000 00



PP*/
TPE

poubelle avec
couvercle flip

680 000 00



PP*/
TPE

kosz na śmieci
z naciskaną
pokrywą

826 000 NN



PP*/
TPE



*recycled PP

10604
magne



abfallbehälter
mit flip-deckel

39,5 x 24 x 47,5
25 l

160 000 00



PP*/ 5 100
TPE

waste bin
with flip lid

315 000 00



PP*/
TPE

poubelle avec
couvercle flip

680 000 00



PP*/
TPE

kosz na śmieci
z naciskaną
pokrywą

826 000 NN



PP*/
TPE



*recycled PP

10605
magne



abfallbehälter
mit flip-deckel

40 x 30 x 61,5
45 l

160 000 00



PP*/ 4 64
TPE

waste bin
with flip lid

315 000 00



PP*/
TPE

poubelle avec
couvercle flip

680 000 00



PP*/
TPE

kosz na śmieci
z naciskaną
pokrywą

826 000 NN



PP*/
TPE



*recycled PP



magne kann swing und flip

Tanzschritte und Skate-Tricks? Nein! Hier geht es um den genialen Abfallbehälter magne. Sein Deckel ist sowohl nach oben aufklappbar als auch nach unten schwingbar. Das macht ihn flexibel einsetzbar. Guter Move, magne!



magne knows how to swing and flip

Dance steps and skate tricks? No! This is about the ingenious waste bin magne. Its lid can be opened upwards and swung downwards. This makes it flexible to use. Good move, magne!

magne sait swinguer et flipper

Des pas de danse et des figures de skate? Non! Il s'agit ici de l'ingénieuse poubelle magne. Son couvercle à la fois s'ouvre vers le haut et pivote vers le bas. Elle est donc utilisable de manière flexible. Bon mouvement, magne!

magne potrafi kręcić się i obracać

I nie chodzi tutaj o taniec, czy sztuczki na łyżwach! Ten sprytny kosz na śmieci posiada pokrywę, którą można otwierać do góry lub odchyłać do dołu. Dzięki temu jest bardzo wygodny w użyciu. Dobry ruch, magne!



anton

hat mal wieder tonnenweise arbeit auf dem tisch.

anton has a ton of work on his desk - again.

anton a de nouveau des tonnes de travail sur son bureau.

anton ma mnóstwo papierkowej roboty na swoim biurku - znowu.



keeper

art.-bezeichnung
article description
désignation
opis produktu

cm/l
cm/l
cm/l
cm/l



farbe
colour
couleur
kolor

ean13
barcode
ean13
kod kreskowy

mat. mam pal.
mat. moq pal.
mat. moq pal.
mat. min. pal.

10300
gunnar



treteimer 39,5 x 29 x 43,5
pedal bin 71 + 15 l

160 000 00



PP* 2 32

poubelle à pédale

kosz na śmieci
z pedalem



*recycled PP

11536
forge



treteimer 37,5 x 29,5 x 46
pedal bin 2 x 11 l

160 000 NN



PP* 2 32

poubelle à pédale

kosz na śmieci
z pedalem



*recycled PP

11599
ole



system-müllsack-
ständer 35 x 40 x 75

160 000 NN



PP 2 48

refuse bag system

système de support
pour sac poubelle

system stojaków
na worki





ella

feht für ihr Leben gern.

ella loves to sweep for a living.

ella aime balayer pour gagner sa vie.

ella uwielbia zmiatać.



torge ist gleich doppelt gut!

In seinen beiden großen Fächern schluckt der Treteimer alles, was ihr ihm gebt – schön ordentlich sortiert.

torge is twice as good! The pedal bin gobbles up everything you throw away into its two big containers and sorts everything perfectly.

torge est doublement bon! Ses deux grands compartiments avalent tout ce que vous leur donnez – en le triant bien comme il faut.

torge jest podwójnie dobry! W obydwu komorach o dużej pojemności mieści się wszystko, czego chcecie się pozbyć – porządnie segregując odpady.



keeper

art.-bezeichnung cm/l
article description cm/l
désignation cm/l
opis produktu cm/l

farbe
colour
couleur
kolor

ean13
barcode
ean13
kod kreskowy

mat. mam pal.
mat. moq pal.
mat. min. pal.

10151
jasper



papierkorb ø 29 x 31
waste-paper basket 11,5 l
poubelle ronde à papier
kosz do papieru

160 000 00



PP* 10 900

826 000 00



PP*



*recycled PP

10212
mats



mini-tonne ø 24,5 x 29
mini-bin 7 l
mini-poubelle baril
mini-pojemnik na śmieci

160 000 00



PP* 5 300

826 000 00



PP*



*recycled PP

10213
mats



maxi-tonne ø 36 x 42
maxi-bin 23 l
maxi-poubelle baril
maxi-pojemnik na śmieci

160 000 00



PP* 6 180

826 000 00



PP*



*recycled PP

10214
mats



supermax-tonne ø 50 x 55
supermax-bin 50 l
poubelle supermax
supermaxi-pojemnik na śmieci

160 000 00



PP* 6 48

826 000 00



PP*



*recycled PP

10219
hugo



mega-tonne ø 55 x 60,5
mega-bin 70 l
poubelle mega
mega-pojemnik na śmieci

259 000 00



PP 3 80





11705
mika



art.-bezeichnung cm/l
article description cm/l
désignation cm/l
opis produktu cm/l



eimer mit ausguss ø 24 x 20
bucket with drain 5 l
seau avec bec verseur
wiadro z wylewką



farbe
colour
couleur
kolor

ean13
barcode
ean13
kod kreskowy

mat. mam pal.
mat. moq pal.
mat. moq pal.
mat. min. pal.

001 000 NN   PP 6 450
4 052396 058437
680 000 00   recycled PP*
4 052396 083477



*recycled PP

11710
mika



eimer mit ausguss ø 30 x 28
bucket with drain 10 l
seau avec bec verseur
wiadro z wylewką



001 000 NN   PP 6 480
4 052396 058444
680 000 00   recycled PP*
4 052396 083484



*recycled PP

10101
erik



eimer ø 24 x 20
bucket 5 l
seau
wiadro

130 000 00   PP* 10 1050
4 052396 082555
680 000 00   PP*
4 052396 082562



*recycled PP

10104
erik



eimer ø 28,5 x 26
bucket 10 l
seau
wiadro

130 000 00   PP* 10 660
4 052396 082579
680 000 00   PP*
4 052396 082586



*recycled PP

10107
bent



putzeimer eckig 42 x 22 x 22,5
cleaning bucket rectangular 13 l
seau rectangulaire
wiadro prostokątne

130 000 00   PP* 10 500
4 052396 082616



*recycled PP

keeper

art.-bezeichnung
article description
désignation
opis produktu

cm/l
cm/l
cm/l
cm/l



farbe
colour
couleur
kolor

ean13
barcode
ean13
kod kreskowy

mat. mam pal.
mat. moq pal.
mat. moq pal.
mat. min. pal.

12600
ilvie „polygon”



deco-eimer ø 30 x 28
deco-bucket 10 l
seau deco
wiadro deco

827 217 00



PP 6 480



12600
ilvie „stars”



deco-eimer ø 30 x 28
deco-bucket 10 l
seau deco
wiadro deco

519 196 00



PP* 6 480



*recycled PP

12600
ilvie „sea life”



deco-eimer ø 30 x 28
deco-bucket 10 l
seau deco
wiadro deco

680 285 00



PP* 6 480



*recycled PP

10787
thies



putzeimer oval 37 x 26,5 x 25
cleaning bucket oval 13 l
seau de nettoyage ovale
wiadro owalne

130 000 00



PP* 6 528

680 000 00



PP*



*recycled PP



pit & pia

fühlen sich beim putzen wie echte stars.

pit & pia feel like real stars
when cleaning.

pit & pia se sentent comme de vraies stars
lorsqu'ils font le ménage.

pit & pia czują się jak prawdziwe gwiazdy,
kiedy sprzątają.



keeper

art.-bezeichnung cm/l
 article description cm/l
 désignation cm/l
 opis produktu cm/l

farbe
 colour
 couleur
 kolor

ean13
 barcode
 ean13
 kod kreskowy

mat. mam pal.
 mat. moq pal.
 mat. min. pal.



10551
 björk



schüssel rund ø 20 x 8
 bowl round 1,5 l
 cuvette ronde
 miska okragta

001 000 00
 315 000 00
 680 000 00



PP 10 3630



10552
 björk



schüssel rund ø 24 x 10
 bowl round 2,5 l
 cuvette ronde
 miska okragta

001 000 00
 315 000 00
 680 000 00



PP 10 2030



10553
 björk



schüssel rund ø 28 x 11
 bowl round 3,5 l
 cuvette ronde
 miska okragta

001 000 00
 315 000 00
 680 000 00



PP 10 1370



10554
 björk



schüssel rund ø 32 x 13
 bowl round 6 l
 cuvette ronde
 miska okragta

001 000 00
 315 000 00
 680 000 00



PP 10 1280





10555
björk



art.-bezeichnung **cm/l**
article description cm/l
désignation cm/l
opis produktu cm/l
↔ ↕

schüssel rund ø 36 x 15
bowl round 9 l
cuvette ronde
miska okrągta



farbe
colour
couleur
kolor

ean13
barcode
ean13
kod kreskowy

mat. mam pal.
mat. moq pal.
mat. moq pal.
mat. min. pal.

001 000 00		4 001515 555012	PP	10	840
315 000 00		4 052396 082463			
680 000 00		4 052396 082487			

10556
björk



schüssel eckig 34 x 34 x 12,5
bowl square 8 l
cuvette carrée
miska kwadratowa



001 000 00		4 001515 556019	PP	10	900
315 000 00		4 052396 082494			
680 000 00		4 052396 082500			

10557
björk



schüssel eckig 38 x 38 x 15
bowl square 13 l
cuvette carrée
miska kwadratowa



001 000 00		4 001515 557016	PP	10	720
315 000 00		4 052396 082517			
680 000 00		4 052396 082524			

10558
björk



schüssel eckig 38 x 32 x 14
bowl rectangular 9 l
cuvette carrée
miska prostokątna



001 000 00		4 001515 558013	PP	10	480
315 000 00		4 052396 082531			
680 000 00		4 052396 082548			

keeper storage



auspacken, anpacken, einpacken.

Zuhause gibt es immer was zu tun. Da wird gebastelt und gebaut. Der eine liebt die Handarbeit, der andere das Handwerk. Und damit euer Material und Werkzeug immer griffbereit und platzsparend verstaut ist, kommt **keeper** mit einer großen Auswahl von Kisten und Boxen um die Ecke. Die einen lassen sich bis unter die Decke stapeln, die anderen lassen sich easy durch die Werkstatt rollen. Also dann: Packen wir es an!

take it, tackle it, tick it off.

There's always something to do around the house. Crafting and building. Some love needlework, others handicrafts. For your tools and materials to be always stored space-savily and ready for use, **keeper** just comes around the corner with a broad selection of boxes and containers. Some can be stacked up under the ceiling, others are easy to roll around. What are you waiting for? Let's tackle it!

déballer, prendre en main, emballer.

À la maison, il y a toujours quelque chose à faire ! On y bricole et on y construit. L'un aime le travail manuel, l'autre le bricolage. Et pour que votre matériel et vos outils restent rangés à portée de main et sans encombrer, **keeper** arrive accompagné d'une grande sélection de caisses et de boîtes. Les unes s'empilent jusqu'au plafond et les autres traversent facilement l'atelier en roulant. Alors : Prenons les choses en main !

rozpakować, naprawić, schować.

W domu zawsze jest coś do zrobienia. A to zepsuty stół, a to ściana do odmalowania. Niektórzy uwielbiają robić na drutach, inni tworzyć piękne rękodzieło z drewna. Aby wszystkie twoje materiały i narzędzia były zawsze wygodnie schowane, **keeper** przygotował całą gamę różnych pudełek, skrzynek i pojemników. Jedne można układać aż do sufitu, inne z łatwością przesuwać tam i z powrotem. Na co więc czekasz? Zrób to sam!

keeper storage





keeper

art.-bezeichnung cm/l
 article description cm/l
 désignation cm/l
 opis produktu cm/l

farbe
 colour
 couleur
 kolor

ean13
 barcode
 ean13
 kod kreskowy

mat. mam pal.
 mat. moq pal.
 mat. moq pal.
 mat. min. pal.



10370
 jonas



stapelkörbchen A7 16 x 12 x 7
 mini storage basket A7
 corbeille A7
 koszyk A7

130 000 00



PP/
 TPE

10

5400

680 000 00



10369
 jonas



stapelkörbchen A6 20 x 16 x 7
 mini storage basket A6
 corbeille A6
 koszyk A6

130 000 00



PP/
 TPE

10

3600

680 000 00



10368
 jonas



stapelkörbchen A5 26,5 x 20 x 7
 mini storage basket A5
 corbeille A5
 koszyk A5

130 000 00



PP/
 TPE

10

1920

680 000 00



10367
 jonas



stapelkörbchen A4 36 x 26,5 x 7
 mini storage basket A4
 corbeille A4
 koszyk A4

130 000 00



PP/
 TPE

10

960

680 000 00





art.-bezeichnung cm/l
 article description cm/l
 désignation cm/l
 opis produktu cm/l



farbe
 colour
 couleur
 kolor

ean13
 barcode
 ean13
 kod kreskowy

mat. mam pal.
 mat. moq pal.
 mat. moq pal.
 mat. min. pal.

10374
mirko



stapelkörbchen A7 16 x 12 x 7
 mini storage basket A7
 corbeille A7
 koszyk A7

001 000 00



PP 10 5400

827 000 00



10373
mirko



stapelkörbchen A6 20 x 16 x 7
 mini storage basket A6
 corbeille A6
 koszyk A6

001 000 00



PP 10 3600

827 000 00



10372
mirko



stapelkörbchen A5 26,5 x 20 x 7
 mini storage basket A5
 corbeille A5
 koszyk A5

001 000 00



PP 10 1920

827 000 00



10371
mirko



stapelkörbchen A4 36 x 26,5 x 7
 mini storage basket A4
 corbeille A4
 koszyk A4

001 000 00



PP 10 960

827 000 00



keeper

art.-bezeichnung	cm/l	farbe	ean13	mat.	mam	pal.
article description	cm/l	colour	barcode	mat.	moq	pal.
désignation	cm/l	couleur	ean13	mat.	moq	pal.
opis produktu	cm/l	kolor	kod kreskowy	mat.	min.	pal.



10940
cornelia



kristallbox	29,5 x 19,5 x 12,5	001 000 00			PP	5	640
crystalbox	4 l			4 001515 940016			
cristalbox		827 000 00					
pojemnik crystalbox				4 052396 082982			

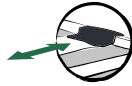

10944
cornelia



kristallbox	39,5 x 29,5 x 9,5	001 000 00			PP	5	320
crystalbox	7 l			4 001515 944014			
cristalbox		827 000 00					
pojemnik crystalbox				4 052396 083002			



10941
cornelia



kristallbox	39,5 x 29,5 x 17,5	001 000 00			PP	5	280
crystalbox	12 l			4 001515 941013			
cristalbox		827 000 00					
pojemnik crystalbox				4 052396 083019			



10945
cornelia



kristallbox	39,5 x 29,5 x 30	001 000 00			PP	5	240
crystalbox	24 l			4 001515 945011			
cristalbox		827 000 00					
pojemnik crystalbox				4 052396 083033			

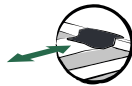



art.-bezeichnung article description désignation opis produktu	cm/l cm/l cm/l cm/l	farbe colour couleur kolor	ean13 barcode ean13 kod kreskowy	mat. mat. mat.	mam moq min.	pal. pal. pal.
---	------------------------------	-------------------------------------	---	----------------------	--------------------	----------------------



10429
cornelia





kristallbox	59,5 x 39,5 x 17	001 000 00	 	PP	5	120
crystalbox	28 l					
crystalbox		827 000 00	 			
pojemnik crystalbox						



10426
cornelia



kristallbox	79,5 x 39,5 x 17	001 000 00	 	PP	5	85
crystalbox	33 l					
crystalbox						
pojemnik crystalbox						



10942
cornelia



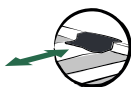

kristallbox	59,5 x 39,5 x 34	001 000 00	 	PP	5	100
crystalbox	52 l					
crystalbox		827 000 00	 			
pojemnik crystalbox						



10427
cornelia



kristallbox	79,5 x 39,5 x 40	001 000 00	 	PP	5	65
crystalbox	83 l					
crystalbox						
pojemnik crystalbox						



keeper

art.-bezeichnung
article description
désignation
opis produktu

cm/l
cm/l
cm/l
cm/l
↔ ↕

farbe
colour
couleur
kolor

ean13
barcode
ean13
kod kreskowy

mat. mam pal.
mat. moq pal.
mat. moq pal.
mat. min. pal.

10439
konrad



kristallbox
mit rollen

59,5 x 39,5 x 18
28 l

001 000 00



PP 5 120

crystalbox
with casters

crystalbox avec roues

pojemnik crystalbox
z kółkami



10436
konrad



kristallbox
mit rollen

79,5 x 39,5 x 18
33 l

001 000 00



PP 5 85

crystalbox
with casters

crystalbox avec roues

pojemnik crystalbox
z kółkami



10943
konrad



kristallbox
mit rollen

59,5 x 39,5 x 35
52 l

001 000 00



PP 5 100

crystalbox
with casters

crystalbox avec roues

pojemnik crystalbox
z kółkami



10437
konrad



kristallbox
mit rollen

79,5 x 39,5 x 41
83 l

001 000 00



PP 5 65

crystalbox
with casters

crystalbox avec roues

pojemnik crystalbox
z kółkami





romy

hat ihre sieben Sachen auf dem rücken und den rest eine weltreise lang in cornelia und konrad verstaut.

romy has all of her belongings on her back and the rest is stowed away in cornelia and konrad for a round the world trip.

romy porte ses affaires sur son dos et a laissé le reste à cornelia et konrad pendant son tour du monde.

romy cały swój dobytek nosi na plecach. w trakcie podróży dookoła świata wszystko inne schowała w pojemnikach cornelia i konrad.



kon-rad. ganz genau.

Der enge Verwandte von cornelia ist gern auf Rädern unterwegs. Besser gesagt: auf Rollen, die seinen Transport absolut easy machen. Sein Deckel ist durch seitliche Clips verschließbar. Eine wahrlich rundrollende Sache!

kon-rad. Exactly. cornelia's close relative loves to travel on wheels. Put more clearly: on roller wheels that make transporting extremely easy. Of course, he is also extremely sturdy. His lid can be closed with clips at the side. Something that really rolls around!

kon-rad. Pour être plus exact. Le parent proche de cornelia se déplace volontiers sur des roues. Ou mieux encore : sur des roulettes qui facilitent absolument son transport. Son couvercle se ferme par des clips latéraux. Une affaire tournant vraiment bien rond !

konrad i cornelia to niezwykle rodzeństwo. Z tym, że konrad preferuje podróżować na kółkach. I to nie byle jakich! Jego transport jest zawsze niezwykle łatwy, a do tego jest też wyjątkowo wytrzymały. Pokrywka dodatkowo zabezpiecza zawartość, dzięki wygodnym zatrzaskom. I tak to się kręci!

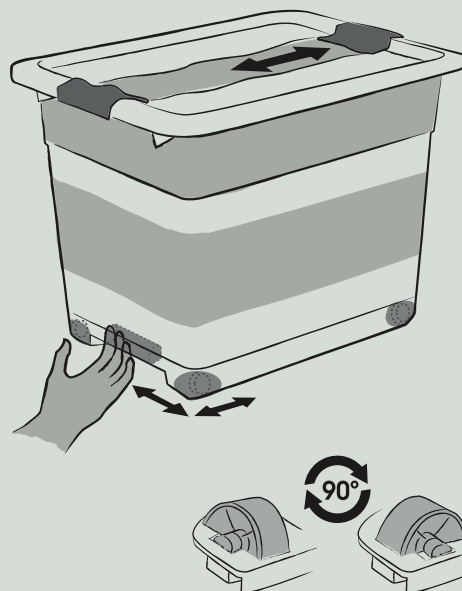

lalala – lara, lars, larissa.

- modular stapelbar
- ansprechendes design
- praktisch in der handhabung
- deckel durch clips verschließbar
- transparenz sorgt für leichten einblick in die box

- modular stackable
- attractive design
- convenient handling
- lid can be closed with clips
- transparency provides easy insight into the box

- module empilable
- design séduisant
- manipulation facile
- le couvercle se ferme à l'aide de clips
- la transparence de la boîte permet de voir le contenu

- modułowo sztaplowane
- atrakcyjny wygląd
- praktyczny w użyciu
- pokrywę można zamknąć za pomocą klipsów
- przezroczystość zapewnia łatwy wgląd do pojemnika



11020
lara



clipbox



19,5 x 15 x 6
1,15 l

001 000 00



PP 5

3840

11022
lara



clipbox



19,5 x 15 x 11
2 l

001 000 00



PP 5

3680

keeper

art.-bezeichnung
article description
désignation
opis produktu

cm/l
cm/l
cm/l
cm/l
↔ ↔ ↑

farbe
colour
couleur
kolor

ean13
barcode
ean13
kod kreskowy

mat. mam pal.
mat. moq pal.
mat. moq pal.
mat. min. pal.



11024
lara



clipbox

19,5 x 15 x 16
3,1

001 000 00



PP 5 3550



11025
lara



clipbox

29 x 20 x 8
3,1 l

001 000 00



PP 5 1440



11029
lara



clipbox

29 x 20 x 18
6,5 l

001 000 00



PP 5 1340



11031
lara



clipbox

39 x 29 x 11
8,5 l

001 000 00



PP 5 520



11033
lara



clipbox

39 x 29 x 21
15,5 l

001 000 00



PP 5 485



keeper

art.-bezeichnung cm/l
article description cm/l
désignation cm/l
opis produktu cm/l
↕ ↔ ↕

farbe
colour
couleur
kolor

ean13
barcode
ean13
kod kreskowy

mat. mam pal.
mat. moq pal.
mat. moq pal.
mat. min. pal.

11040
lars

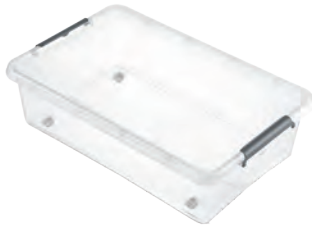

clipbox
mit rollen 58 x 39 x 16
29 l

001 000 00



PP 5 240

clipbox
with casters

clipbox avec roues

clipbox z kółkami



11041
lars



clipbox
mit rollen 76 x 39 x 16
35 l

001 000 00



PP 5 170

clipbox
with casters

clipbox avec roues

clipbox z kółkami



11042
lars

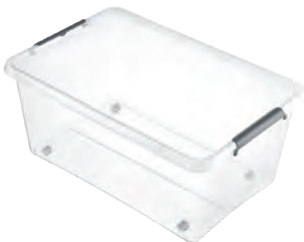

clipbox
mit rollen 58 x 39 x 25
40 l

001 000 00



PP 5 220

clipbox
with casters

clipbox avec roues

clipbox z kółkami



11044
lars



clipbox
mit rollen 58 x 39 x 35
60 l

001 000 00



PP 5 200

clipbox
with casters

clipbox avec roues

clipbox z kółkami





art.-bezeichnung
article description
désignation
opis produktu

cm/l
cm/l
cm/l
cm/l



farbe
colour
couleur
kolor

ean13
barcode
ean13
kod kreskowy

mat. mam pal.
mat. moq pal.
mat. moq pal.
mat. min. pal.

11045
lars

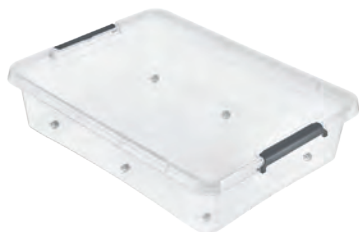

clipbox
mit rollen

76 x 57 x 18
61 l

001 000 00



PP 5 80

clipbox
with casters

clipbox avec roues

clipbox z kółkami



11047
lars



clipbox
mit rollen

58 x 39 x 42
80 l

001 000 00



PP 5 175

clipbox
with casters

clipbox avec roues

clipbox z kółkami



11048
lars



clipbox
mit rollen

76 x 57 x 42
145 l

001 000 00



PP 5 65

clipbox
with casters

clipbox avec roues

clipbox z kółkami

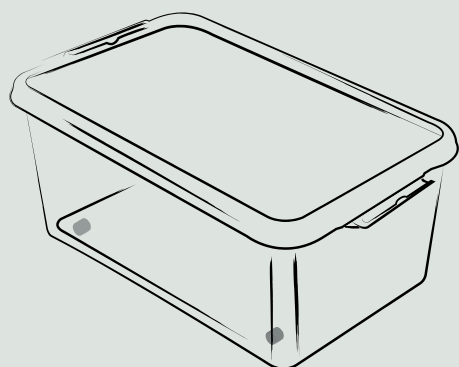

**Vollpacken, schließen und
ab geht das Rollenspiel.**

Pack up, close and off you go rolling.

Charger, fermer et c'est parti pour le jeu à roulettes.

Zapakuj, zamknij i ruszaj w drogę.

keeper

art.-bezeichnung
article description
désignation
opis produktu

cm/l
cm/l
cm/l
cm/l



farbe
colour
couleur
kolor

ean13
barcode
ean13
kod kreskowy

mat. mam pal.
mat. moq pal.
mat. moq pal.
mat. min. pal.

10574
bea

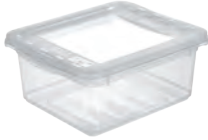

clearbox

19,5 x 16,5 x 8,5
1,7 l

001 000 00



PP 6 864



10578
bea



clearbox

33 x 19,5 x 12
5,6 l

001 000 00



PP 6 672



10575
bea



clearbox

39 x 26,5 x 10
8 l

001 000 00



PP 6 432



10576
bea



clearbox

39 x 33,5 x 9
9 l

001 000 00



PP 6 288



gesa

mag es gern gut sortiert.

gesa likes things well organised.

gesa aime les choses bien rangées.

gesa lubi, gdy rzeczy są dobrze posegregowane.



91



Wie man sie auch dreht und wendet: bea ist ein Knüller! Die Box ist ideal geeignet für die Aufbewahrung von Bekleidung, Accessoires, Schuhen und Gürteln und bringt Ordnung ins Regal – staubsicher, perfekt stapelbar und jederzeit einsehbar. Das einzigartige Air-Control-System sorgt entweder für frischen Wind oder einen luftdichten Verschluss – je nachdem, wie ihr den Deckel dreht.

How she twists and turns: bea is a bestseller! The box is ideally suited for storing clothes, accessories, shoes and belts, and tidies up your shelves. It is dust-proof, can be perfectly stacked and is always ready to hand. The unique air-control system provides either a fresh breeze or an airtight lock depending on how you turn the lid.

On peut la tourner dans tous les sens : bea reste épatante ! La boîte idéale pour le rangement de vêtements, accessoires, chaussures et ceintures, elle met de l'ordre dans les étagères – elle protège de la poussière, s'empile à la perfection et présente son contenu sans s'ouvrir. Le système Air-Control unique en son genre assure soit une bonne aération soit une fermeture hermétique – selon la position du couvercle.

Czy się skręca, czy odwraca: bea jest bestsellerem! Ten pojemnik idealnie nadaje się do przechowywania odzieży, akcesoriów i butów, porządkując nasze półki. Jest pyłoodporny, może stać jeden na drugim, a do tego jest bardzo poręczny. Wyjątkowy system kontroli powietrza zapewnia wentylację lub szczelną blokadę, w zależności od tego jak obrócisz pokrywkę.

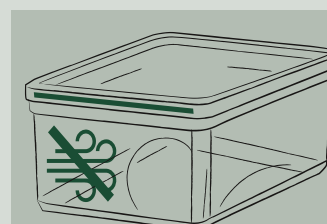
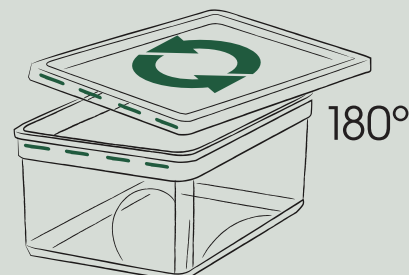
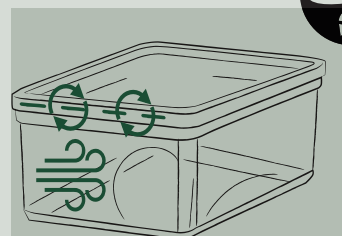

keeper

art.-bezeichnung
article description
désignation
opis produktu

cm/l
cm/l
cm/l



farbe
colour
couleur
kolor

ean13
barcode
ean13
kod kreskowy

mat. mam pal.
mat. moq pal.
mat. moq pal.
mat. min. pal.

10579
bea



clearbox

39 x 26,5 x 14
11 l

001 000 00



PP 6 378



10577
bea



clearbox

39 x 33,5 x 18
18 l

001 000 00



PP 6 252



10580
bea



clearbox

39 x 33,5 x 32
30 l

001 000 00



PP 6 180



10582
bea



clearbox

59 x 39 x 18
30 l

001 000 00



PP 6 144





art.-bezeichnung	cm/l	farbe	ean13	mat.	mam	pal.
article description	cm/l	colour	barcode	mat.	moq	pal.
désignation	cm/l	couleur	ean13	mat.	moq	pal.
opis produktu	cm/l	kolor	kod kreskowy	mat.	min.	pal.



10569
bea



clearbox 59 x 39 x 27 001 000 00 4 052396 096248 PP 6 120



10583
bea



clearbox 59 x 39 x 35 001 000 00 4 052396 022100 PP 6 120



10570
bert



clearbox mit rollen 59 x 39 x 42 001 000 00 4 052396 096255 PP 6 120

clearbox
with casters

clearbox
avec roues

pojemnik clearbox
z kółkami



10566
bert



clearbox mit rollen 76 x 57 x 42 001 000 00 4 052396 096262 PP 6 60

clearbox
with casters

clearbox
avec roues

pojemnik clearbox
z kółkami



keeper

art.-bezeichnung
article description
désignation
opis produktu

cm/l
cm/l
cm/l
cm/l



farbe
colour
couleur
kolor

ean13
barcode
ean13
kod kreskowy

mat. mam pal.
mat. moq pal.
mat. moq pal.
mat. min. pal.

30019
bea



clearbox set

33 x 19,5 x 22

001 000 00



PP 3 98

4 x 5,6 l á
33 x 19,5 x 12

827 000 00



30020
bea



clearbox set

39 x 26,5 x 21,5

001 000 00



PP 3 72

3 x 11 l á
39 x 26,5 x 14

827 000 00



30031
bea



clearbox set

39 x 33,5 x 25

001 000 00



PP 3 42

3 x 18 l á
39 x 33,5 x 18

827 000 00



30050
bea



clearbox set

39 x 33,5 x 25

001 000 00



PP 3 42

3 x 1,7 l á
19,5 x 16,5 x 8,5

2 x 5,6 l á
33 x 19,5 x 12

3 x 18 l á
39 x 33,5 x 18





10066
luis



art.-bezeichnung **cm/l**
article description cm/l
désignation cm/l
opis produktu cm/l
↔ ↕

euro-box mit
softgriffen 39 x 29 x 22
20 l

eurobox with
soft-grips

euro-box avec
poignées souples

pojemnik eurobox
z miękkimi
uchwytyami

farbe
colour
couleur
kolor

001 000 00

ean13
barcode
ean13
kod kreskowy



4 052396 022117

mat. mam pal.
mat. moq pal.
mat. moq pal.
mat. min. pal.

PP/ 6 96
TPE



10068
luis



euro-box mit
softgriffen 59 x 39 x 32
64 l

eurobox with
soft-grips

euro-box avec
poignées souples

pojemnik eurobox
z miękkimi
uchwytyami

001 000 00



4 052396 022131

PP/ 6 36
TPE



robin & sammy

denken beim umzug
out-of-the-box.

robin & sammy think out-of-
the-box when moving.

robin & sammy pensent out-of-
the-box lors d'un déménagement.

robin & sammy podczas prze-
prowadzki zastosowali zasadę
myślenia out-of-the-box.



keeper

art.-bezeichnung

article description
désignation
opis produktu

cm/l

cm/l
cm/l
cm/l



farbe

colour
couleur
kolor

ean13

barcode
ean13
kod kreskowy

mat. mam pal.

mat. moq pal.
mat. moq pal.
mat. min. pal.

10882
robert



transportbox
tragkraft bis 30 kg
20 l

130 000 00



PP 6 96

transport box
loading capacity
up to 30 kg

826 000 00



boîte de transport
jusqu'à 30 kg
de capacité de
chargement

pojemnik transportowy
o ładowności do 30 kg



10884
robert



transportbox
tragkraft bis 60 kg
45 l

130 000 00



PP 4 36

transport box
loading capacity
up to 60 kg

826 000 00



boîte de transport
jusqu'à 60 kg
de capacité de
chargement

pojemnik transportowy
o ładowności do 60 kg



10886
robert



transportbox
tragkraft bis 60 kg
64 l

130 000 00



PP 6 36

transport box
loading capacity
up to 60 kg

826 000 00



boîte de transport
jusqu'à 60 kg
de capacité de
chargement

pojemnik transportowy
o ładowności do 60 kg



10877
rolf



transportroller für
transportboxen und
-körbe

400 000 00



PE 3 36

transport roller for
transport boxes and
baskets

plateau de transport
à roues pour transport
box et basket

wózek transportowy
dla pojemników
i koszy transportowych





art.-bezeichnung	cm/l	farbe	ean13	mat.	mam	pal.
article description	cm/l	colour	barcode	mat.	moq	pal.
désignation	cm/l	couleur	ean13	mat.	moq	pal.
opis produktu	cm/l	kolor	kod kreskowy	mat.	min.	pal.



10883 robert



transportkorb
tragkraft bis 30 kg
60 x 40 x 12
22 l

transport basket
loading capacity
up to 30 kg

basket de transport
jusqu'à 30 kg de
capacité de
chargement

kosz transportowy
o ładowności 30 kg



www.euro.com
02 111221916



4 052396 083132

PP 8 64

10885 robert



transportkorb
tragkraft bis 60 kg
60 x 40 x 32
64 l

transport basket
loading capacity
up to 60 kg

basket de transport
jusqu'à 60 kg de
capacité de
chargement

kosz transportowy
o ładowności 60 kg



www.euro.com
02 111221916



4 052396 083149

PP 6 36

10828 roberta



deckel für
transportbox
40 x 30
130 000 00

lid for
transport box
826 000 00

couvercle pour boîte
de transport

pokrywa do
pojemnika



4 052396 083156

PP 10 840



4 052396 011425

10829 roberta



deckel für
transportbox
und -korb
60 x 40
130 000 00

lid for
transport box
and basket
826 000 00

couvercle pour boîte
et basket de transport

pokrywa do
pojemnika/kosza



4 052396 083170

PP 10 440



4 052396 011432

keeper

art.-bezeichnung	cm/l	farbe	ean13	mat.	mam	pal.
article description	cm/l	colour	barcode	mat.	moq	pal.
désignation	cm/l	couleur	ean13	mat.	moq	pal.
opis produktu	cm/l	kolor	kod kreskowy	mat.	min.	pal.



10844 eckhart



transportbehälter extra stabil	39,5 x 29,5 x 17,5 12 l	826 000 00			PP	5	280
transport box extra strong				4 052396 015072			
transport box extra-solide							
pojemnik transportowy extra strong							



10845 eckhart



transportbehälter extra stabil	39,5 x 29,5 x 30 24 l	826 000 00			PP	5	240
transport box extra strong				4 052396 015096			
transport box extra-solide							
pojemnik transportowy extra strong							



10831 eckhart



transportbehälter extra stabil	79,5 x 39,5 x 17 33 l	826 000 00			PP	5	85
transport box extra strong				4 052396 031577			
transport box extra-solide							
pojemnik transportowy extra strong							



10847 eckhart



transportbehälter extra stabil	59,5 x 39,5 x 34 52 l	826 000 00			PP	5	100
transport box extra strong				4 052396 015089			
transport box extra-solide							
pojemnik transportowy extra strong							



art.-bezeichnung
article description
désignation
opis produktu

cm/l
cm/l
cm/l
cm/l



farbe
colour
couleur
kolor

ean13
barcode
ean13
kod kreskowy

mat. mam pal.
mat. moq pal.
mat. moq pal.
mat. min. pal.

10830
eckhart



transportbehälter
extra stabil

79,5 x 39,5 x 40
83 l

826 000 00



PP 5 65

transport box
extra strong

transport box
extra-solide

pojemnik
transportowy
extra strong

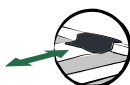

mick

legt wert auf jeden millimeter.

mick places importance
on every single millimetre.

mick se penche sur
chaque millimètre.

mick przywiązuje wagę
do każdego milimetra.



keeper

art.-bezeichnung
article description
désignation
opis produktu

cm/l
cm/l
cm/l
cm/l



farbe
colour
couleur
kolor

ean13
barcode
ean13
kod kreskowy

mat. mam pal.
mat. moq pal.
mat. moq pal.
mat. min. pal.

10296
lea



profi-klappbox
mit softgriffen

48,5 x 35 x 23,5
32 l

437 000 00



PP/ 5 200
TPE

folding box
with soft-grips

680 000 00



casier pliant
avec poignées
souples

kosz składany
z miękkimi
uchwytyami



10297
ben



profi-klappbox
mit softgriffen

54 x 37 x 28
45 l

160 000 00



PP/ 5 120
TPE

folding box
with soft-grips

315 000 00



casier pliant
avec poignées
souples

680 000 00



kosz składany
z miękkimi
uchwytyami

826 000 00



mit ben klappt's endlich

Den Einkauf tragen, Altglas wegbringen, Picknick im Grünen ... Endlich mal einer, der immer alles mitmacht – und sich schmal macht, wenn es nix zu tun gibt.

with ben, it finally works

Carrying the shopping, taking away old glass, picnics in the countryside ... Finally, someone who always does everything - and makes himself look small when there is nothing to do.

avec ben, ça marche enfin

Porter les courses, emporter le verre usagé, pique-niquer dans la nature ... Enfin quelqu'un qui fait toujours tout - et qui se fait tout petit quand il n'y a rien à faire.

z benem wszystko działa

Noszenie zakupów, wynoszenie starych szklanek, pikniki w parku... Wreszcie ktoś, kto zawsze robi wszystko - a kiedy nie ma nic do zrobienia, potrafi się łatwo schować.

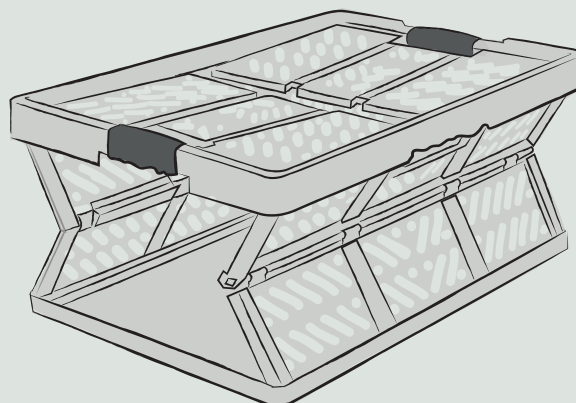

kora

kauff gern kistenweise köstlichkeiten.

kora likes to buy deliciousness
by the box.

kora aime acheter des caisses
de délices.

kora lubi kupować pyszności
na szuki.

101



10224
ida



klappbox
folding box
casier pliant
kosz składany

48 x 35 x 23
32 l

800 000 00



PP* 5 170



*recycled PP

10659
inka



picknick-korb mit
deckel und henkeln
28 l

picnic basket with lid
and handles

panier pique-nique
avec couvercle et
anse

koszyk piknikowy z
pokrywą i uchwytami

130 000 00



PP 5 75

437 000 00



10878
alma



einkaufskorb
shoppy basket

40 x 29 x 22,5
15 l

130 000 00



PP 10 720

panier à provisions
koszyk na zakupy

680 000 00



keeper

art.-bezeichnung
article description
désignation
opis produktu

cm/l
cm/l
cm/l
cm/l
↕ ↔ ↗

farbe
colour
couleur
kolor

ean13
barcode
ean13
kod kreskowy

mat. mam pal.
mat. moq pal.
mat. moq pal.
mat. min. pal.

10541
emil



dreh-/stapelbox 35 x 20,5 x 15
turn around stacking box 7 l
boîte empilable/retournable
skrzynka obrotowa



001 000 00
315 000 00
680 000 00



PP 10 660
recycled PP*
recycled PP*

10546
emil



dreh-/stapelbox 38 x 28,5 x 20,5
turn around stacking box 15 l
boîte empilable/retournable
skrzynka obrotowa



001 000 00
315 000 00
680 000 00



PP 10 360
recycled PP*
recycled PP*

10188
emil



dreh-/stapelbox 41 x 34,5 x 22
turn around stacking box 24 l
boîte empilable/retournable
skrzynka obrotowa



001 000 00
315 000 00
680 000 00



PP 10 270
recycled PP*
recycled PP*

10516
emil



dreh-/stapelbox 44,5 x 34,5 x 27
turn around stacking box 30 l
boîte empilable/retournable
skrzynka obrotowa



001 000 00
315 000 00
680 000 00



PP 10 220
recycled PP*
recycled PP*

10536
emil



dreh-/stapelbox 54,5 x 39 x 29,5
turn around stacking box 45 l
boîte empilable/retournable
skrzynka obrotowa



001 000 00
315 000 00
680 000 00



PP 10 120
recycled PP*
recycled PP*



	art.-bezeichnung article description désignation opis produktu	cm/l cm/l cm/l cm/l	farbe colour couleur kolor	ean13 barcode ean13 kod kreskowy	mat. mat. mat.	mam moq moq	pal. pal. pal. pal.
10542 emilia	deckel für dreh-/stapelbox 7 l lid for turn around stacking box 7 l couvercle pour boîte empilable/ retournable 7 l pokrywa do skrzynki obrotowej 7 l	35,5 x 21	001 000 00	4 001515 542012	PP	10	4640
10547 emilia	deckel für dreh-/stapelbox 15 l lid for turn around stacking box 15 l couvercle pour boîte empilable/ retournable 15 l pokrywa do skrzynki obrotowej 15 l	38 x 29	001 000 00	4 001515 547017	PP	10	3120
10180 emilia	deckel für dreh-/stapelbox 24 l lid for turn around stacking box 24 l couvercle pour boîte empilable/ retournable 24 l pokrywa do skrzynki obrotowej 24 l	42,5 x 35,5	001 000 00	4 001515 180016	PP	10	830
10517 emilia	deckel für dreh-/stapelbox 30 l lid for turn around stacking box 30 l couvercle pour boîte empilable/ retournable 30 l pokrywa do skrzynki obrotowej 30 l	45,5 x 35,5	001 000 00	4 001515 517010	PP	10	800
10537 emilia	deckel für dreh-/stapelbox 45 l lid for turn around stacking box 45 l couvercle pour boîte empilable/ retournable 45 l pokrywa do skrzynki obrotowej 45 l	55,5 x 40	001 000 00	4 001515 537018	PP	10	1360

keeper

art.-bezeichnung
article description
désignation
opis produktu

cm/l
cm/l
cm/l



farbe
colour
couleur
kolor

ean13
barcode
ean13
kod kreskowy

mat. mam pal.
mat. moq pal.
mat. moq pal.
mat. min. pal.

10271
franz



multi-box s

35 x 21 x 15
6,5 l

001 000 00



PP 10 420

827 000 00



10272
franz



multi-box m

35 x 27 x 21
13,5 l

001 000 00



PP 10 400

827 000 00



10273
franz



multi-box l

43 x 35 x 15
16 l

001 000 00



PP 10 210

827 000 00



10274
franz



multi-box xl

43 x 35 x 23
24 l

001 000 00



PP 10 210

827 000 00



10275
franz



multi-box xxl

52 x 43 x 26
44 l

001 000 00



PP 10 120

827 000 00





	art.-bezeichnung article description désignation opis produktu	cm/l cm/l cm/l cm/l	farbe colour couleur kolor	ean13 barcode ean13 kod kreskowy	mat. mat. mat.	mam moq moq min.	pal. pal. pal.
10246 franziska	deckel für multi-box s lid for multi-box s couvercle pour multi-box s pokrywa do multi-box s	35 x 21	001 000 00		PP	10	1600
			827 000 00				
10247 franziska	deckel für multi-box m lid for multi-box m couvercle pour multi-box m pokrywa do multi-box m	35 x 27	001 000 00		PP	10	1280
			827 000 00				
10248 franziska	deckel für multi-box l + xl lid for multi-box l + xl couvercle pour multi-box l + xl pokrywa do multi-box l + xl	43 x 35	001 000 00		PP	10	600
			827 000 00				
10249 franziska	deckel für multi-box xxl lid for multi-box xxl couvercle pour multi-box xxl pokrywa do multi-box xxl	52 x 43	001 000 00		PP	10	420
			827 000 00				

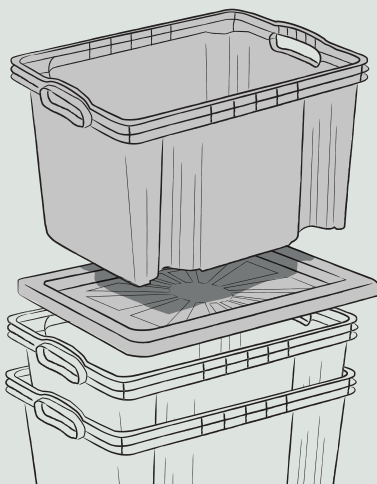

franz der kann's

Stilsicher und stabil verwahrt er allerlei Dinge. Und im Duo mit franziska heißt es: Deckel drauf und gut!

franz - yes he can
Stylish and stable, he
stores all kinds of things.
And in a duo with fran-
ziska, it's: lid on and
good!

franz, il sait y faire
Il conserve toutes sortes
de choses avec style
et stabilité. Et en duo
avec franziska, c'est :
couvercle sur le dessus
et c'est bon!

franz - oj tak, on potrafi
duzo.
Stylowy i stateczny,
przechowuje wszyst-
kie rzeczy. A najlepiej
się czuje w duecie z
franziską!

keeper

art.-bezeichnung
article description
désignation
opis produktu

cm/l
cm/l
cm/l
cm/l



farbe
colour
couleur
kolor

ean13
barcode
ean13
kod kreskowy

mat. mam pal.
mat. moq pal.
mat. moq pal.
mat. min. pal.

15461
bruno



euro-box m

35 x 27 x 22
16 l

001 000 NN



PP 6 96

827 000 00



15456
bruno



euro-box l

43 x 35 x 17,5
20,5 l

001 000 NN



PP 6 66

827 000 00



15453
bruno



euro-box xl

43 x 35 x 24
28 l

001 000 NN



PP 6 72

827 000 00



15399
bruno

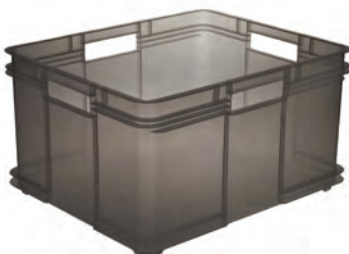

euro-box xxl

52 x 43 x 28
54 l

001 000 NN



PP 6 36

827 000 00





jona & mila

weihen ihre neue wohnung
schon eine woche früher ein.

jona & mila christen their new flat
a week early.

jona & mila peuvent emménager une
semaine plus tôt que prévu.

jona & mila zrobili parapetówkę
tydzień przed przeprowadzką.

10230
tim



trittthocker
step stool
tabouret
taboret

36,5 x 30 x 24

160 000 00



PP 5 210

826 000 00



10902
max



maxi-hocker
maxi-stool
maxi tabouret
taboret maxi

41 x 33,5 x 42,5

160 000 00



PP 5 120

826 000 00



keeper

art.-bezeichnung
article description
désignation
opis produktu

cm/l
cm/l
cm/l
cm/l



farbe
colour
couleur
kolor

ean13
barcode
ean13
kod kreskowy

mat. mam pal.
mat. moq pal.
mat. moq pal.
mat. min. pal.

10125
fred



körbchen 25 x 17 x 10
mini basket
mini panier
koszyk nastawny

001 000 00



PP 10 1890

827 000 00



10126
fred



körbchen 30 x 20 x 11
mini basket
mini panier
koszyk nastawny

001 000 00



PP 10 1440

827 000 00



10390
fritz



dreh-/stapelkorb s 30 x 20 x 13
turn-around
stacking basket s
boîte retournable/
empilable s
koszyk obrotowy s

001 000 00



PP 10 960

10391
fritz



dreh-/stapelkorb m 40 x 25 x 15
turn-around
stacking basket m
boîte retournable/
empilable m
koszyk obrotowy m

001 000 00



PP 10 660



art.-bezeichnung
article description
désignation
opis produktu

cm/l
cm/l
cm/l
cm/l
↔ ↔ ↓

farbe
colour
couleur
kolor

ean13
barcode
ean13
kod kreskowy

mat. mam pal.
mat. moq pal.
mat. moq pal.
mat. min. pal.

10136
wilma



wännchen
mini tub
mini box
pojemnik

30 x 20 x 11
4,5 l

001 000 00
827 000 00



PP 10 1280

elisabeth

verteilt körbe – im ganzen haus.

elisabeth solves the chaos –
everywhere in the house.

elisabeth distribue des paniers –
dans toute la maison.

elisabeth pokonała chaos –
w szczególności ten w domu.

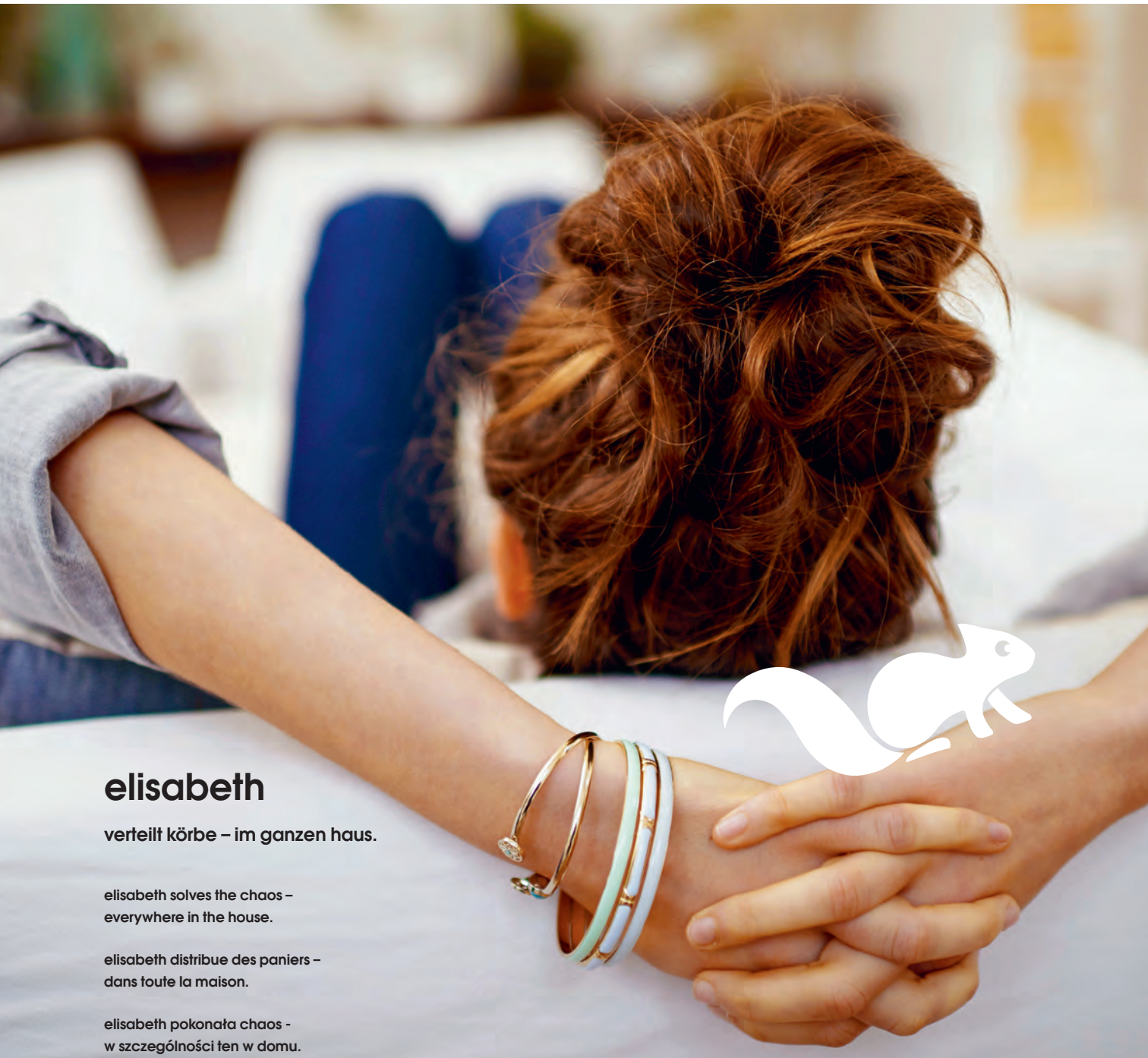

keeper kids

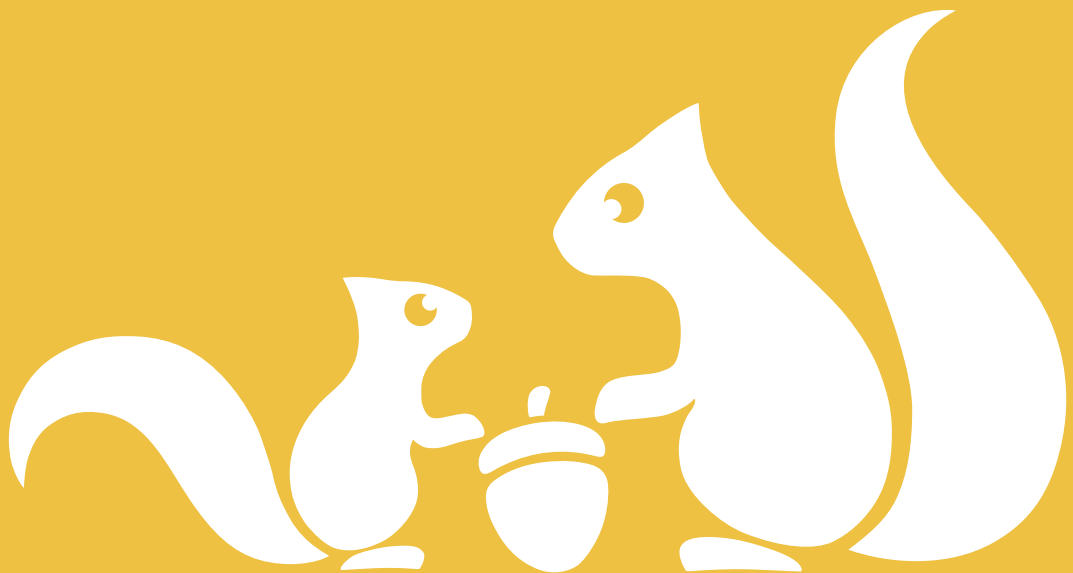

kunterbunter kinderkrum.

Von minnie bis winnie und von peppa bis paw patrol ... Das sind die großen Helden unserer kleinen Helden. Sie begleiten die Kids beim Großwerden und verhelfen mit tollen Motiven auf noch tolleren Produkten von der Badewanne über den Toilettensitz bis hin zum Tritthocker zu immer mehr Selbstständigkeit. Und damit weder Ordnung noch die vielen Kindheitserinnerungen zu kurz kommen, warten die zahlreichen Aufbewahrungsmöglichkeiten nur darauf, von euch mit Leben und Liebe gefüllt zu werden.

crazy colours for kids.

From minnie to winnie and from peppa to paw patrol ... They are the big heroes for our little heroes. They are always with the kids and help them grow up with their cool pictures on even cooler products ranging from the bath tub to the toilet seat to the step stool, towards being increasingly more independent. And for the perfect balance between order and childhood memories, our countless storage appliances are just waiting to be full of your life and love.

trucs d'enfants de toutes les couleurs.

De minnie à winnie et de peppa à la paw patrol ... Ce sont les grands héros de nos petits héros. Ils accompagnent les enfants pendant leur croissance et, avec leurs motifs magnifiques, ils les aident à gagner une plus grande autonomie sur des produits encore plus superbes de la salle de bains au tabouret, en passant par le siège des toilettes. Et afin de ne négliger ni l'ordre ni les nombreux souvenirs d'enfance, les nombreuses possibilités de conservation n'attendent qu'une chose : que vous les remplissiez de vie et d'amour.

kolorowy świat dzieci.

Myszka mickey, kubuś puchatek, świnka peppa, a może psi patrol? Każdy mały bohater ma swojego wielkiego bohatera. W końcu są razem od pierwszych dni życia. Wspólnie rosną i poznają świat - od wanny i fotelika, przez nocnik i nakładkę, aż po podest, który prowadzi ku samodzielności. A żeby zapewnić idealną równowagę pomiędzy porządkiem, a wspomnieniami z dzieciństwa, nasze niezliczone pojemniki do przechowywania już czekają, aby je wypełnić.

keeper kids







Disney

kasimir 4 in 1 der thron, der mitwächst

kasimir 4 in 1: the throne that grows with you
kasimir 4 en 1: le trône qui grandit avec toi
kasimir 4 w 1: tron, który rośnie razem z tobą.

es war einmal ... eine windel!

Vom ersten Töpfchengang – der Thronbesteigung – über die Nutzung des Toilettensitzes zum Tritthocker-Einsatz: kasimir 4 in 1 bietet absoluten Komfort für Babys bzw. Kleinkinder durch eine passgerechte und anatomische Form. Mit pflegeleichter Oberfläche und herausnehmbarem Auffangbehälter ist nicht nur kasimir einfach zu reinigen: Dank praktischem Feuchttuchspender bleibt auch der oder die Thronende immer sauber. Die Anti-Rutsch-Funktion garantiert einen sicheren Halt und eine stabile Sitzposition. So kann man sich ganz dem Sitz der Krone widmen. Herrschaftlich!

once upon a time ... a diaper!

From the first potty walk - the ascent to the throne - to the use of the toilet seat to the step stool insert: kasimir 4 in 1 offers absolute comfort for babies or toddlers thanks to a fitting and anatomical shape. With an easy-care surface and removable collecting tank, not only kasimir is easy to clean: Thanks to a practical wipe dispenser, the enthroning one also always stays clean. The antislip function guarantees a secure hold and a stable sitting position. So you can devote yourself entirely to the seat of the crown. Lordly!

il était une fois ... une couche !

Du premier pot - l'accession au trône - à l'utilisation du siège de toilettes jusqu'à l'insert du tabouret marche-pied: kasimir 4 en 1 offre un confort absolu aux bébés ou aux jeunes enfants grâce à une forme adaptée et anatomique. Avec sa surface facile à entretenir et son réservoir amovible, kasimir n'est pas le seul à être facile à nettoyer: Grâce au pratique distributeur de lingettes humides, le ou la qui trône reste lui aussi toujours propre. La fonction antidérapante garantit un maintien sûr et une position assise stable. On peut ainsi se consacrer entièrement à l'assise de la couronne. Magnifique!

dawno, dawno temu była... pielucha!

Teraz nadszedł czas na nowego bohatera. kasimir nocnik 4w1 to tron, który rośnie razem z dzieckiem. Od pierwszego użycia nocnika – tzn. wejścia na tron - do korzystania jako nakładka sedesowa i podest. kasimir dba o swojego władcę i pomaga mu w osiągnięciu celów. Dzięki wyjmowanemu zbiorniczkowi nie tylko kasimir jest łatwy w czyszczeniu: za pomocą praktycznego pojemnika na mokre chusteczki, również ten, kto na nim zasiada, zawsze pozostanie czysty. Tak, aby móc w pełni skupić się na noszeniu korony. Niech żyje król i królowa!

keeper

art.-bezeichnung
article description
désignation
opis produktu

cm/l
cm/l
cm/l



farbe
colour
couleur
kolor

ean13
barcode
ean13
kod kreskowy

mat. mam pal.
mat. moq pal.
mat. moq pal.
mat. min. pal.



18678
kasimir „winnie“

4
in 1



babytopf deluxe
4in 1

35 x 31,5 x 26

100 238 00



PP/
TPE

1

36

potty deluxe
4in 1

pot bébé deluxe
4en1

nocnik deluxe
4w1



reddot winner 2022

18678
kasimir „minnie“

4
in 1



babytopf deluxe
4in 1

35 x 31,5 x 26

581 247 00



PP/
TPE

1

36

potty deluxe
4in 1

pot bébé deluxe
4en1

nocnik deluxe
4w1



reddot winner 2022

18678
kasimir „mickey“

4
in 1



babytopf deluxe
4in 1

35 x 31,5 x 26

684 247 00



PP/
TPE

1

36

potty deluxe
4in 1

pot bébé deluxe
4en1

nocnik deluxe
4w1



reddot winner 2022

keeper

art.-bezeichnung
article description
désignation
opis produktu

cm/l
cm/l
cm/l



farbe
colour
couleur
kolor

ean13
barcode
ean13
kod kreskowy

mat. mam pal.
mat. moq pal.
mat. moq pal.
mat. min. pal.

18649
kasimir



4
in 1

babytopf deluxe
4in 1

35 x 31,5 x 26

519 000 00



PP/ 1 36
TPE

potty deluxe
4in 1

pot bébé deluxe
4en1

nocnik deluxe
4w1



reddot winner 2022

18649
kasimir



4
in 1

babytopf deluxe
4in 1

35 x 31,5 x 26

581 000 00



PP/ 1 36
TPE

potty deluxe
4in 1

pot bébé deluxe
4en1

nocnik deluxe
4w1



reddot winner 2022

18649
kasimir



4
in 1

babytopf deluxe
4in 1

35 x 31,5 x 26

684 000 00



PP/ 1 36
TPE

potty deluxe
4in 1

pot bébé deluxe
4en1

nocnik deluxe
4w1



reddot winner 2022



schritt für schritt ein thron wächst mit.

step by step – throne and you go ahead.

pas à pas. – un trône grandit avec toi.

krok po kroku. – razem z tronem podbijesz świat.

1

töpfchen: kasimir und die thronbesteigung

potty: kasimir and the ascent to the throne

pot: kasimir et l'accession au trône

nocnik: kasimir zasiada na tronie



2

toilettenaufsatz: kasimir sichert den sitz der herrschaft

toilet training seat: kasimir secures the seat of dominion

siège de toilette: kasimir sécurise le siège de la seigneurie

nakładka sedesowa: kasimir zajmuje miejsce panowania

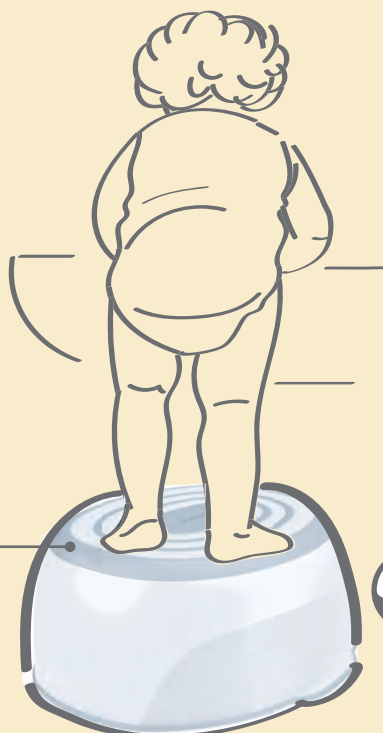

3

trittthocker: kasimir und die eroberung des großen throns

step stool: kasimir and the conquest of the great throne

marche pied: kasimir et la conquête du grand trône

podest: kasimir i zdobycie wielkiego tronu



4

feuchttuchspender: Immer wieder ein happy end

wipe dispenser: always a happy ending

compartiments à lingettes: toujours un happy end

pojemnik na chusteczki: zawsze szczęśliwe zakończenie

keeper

art.-bezeichnung cm/l
 article description cm/l
 désignation cm/l
 opis produktu cm/l



farbe
 colour
 couleur
 kolor

ean13
 barcode
 ean13
 kod kreskowy

mat. mam pal.
 mat. moq pal.
 mat. moq pal.
 mat. min. pal.

18423
maria „winnie“



babywanne 84 cm 84 x 49 x 29
 mit stöpsel

100 238 00



PP 5 255

baby bath 84 cm
 with plug

baignoire 84 cm
 avec vidange

wanienka 84 cm
 z korkiem



18420
maria „winnie“



babywanne 100 cm 100 x 51 x 29
 mit stöpsel

100 238 00



PP 5 200

baby bath 100 cm
 with plug

baignoire 100 cm
 avec vidange

wanienka 100 cm
 z korkiem



18618
leon „winnie“



anatomischer 53 x 25 x 22
 babybadesitz mit anti-
 rutsch-funktion

100 238 00



PP/ 5 330
 TPE

anatomic
 baby bath chair with
 anti-slip-function

siège de bain
 ergonomique
 antidérapant

anatomiczny fotelik
 do kąpieli z funkcją
 antypoślizgową

11800
karol „winnie“



windeleimer 37 x 29,5 x 27,5
 mit deckel und trage-
 griff

100 238 00



PP 5 160

nappy-bin
 with lid and handle

seau à langes
 avec couvercle
 et anse

wiadro na pieluchy
 z pokrywą i rączką



	art.-bezeichnung article description désignation opis produktu	cm/l cm/l cm/l cm/l	farbe colour couleur kolor	ean13 barcode ean13 kod kreskowy	mat. mat. mat.	mam moq moq	pal. pal. pal. pal.
18670 adam „winnie“	babytopf mit anti-rutsch-funktion potty with anti-slip-function pot bébé antidérapant nocnik z funkcją antypoślizgową	38 x 27 x 23,5	100 238 00	 4 052396 071757	PP/ TPE	5	855
10819 ewa „winnie“	kinder-toilettensitz mit anti-rutsch- funktion toilet training seat with anti-slip- function réducteur de siège wc antidérapant nakładka sedesowa z funkcją antypoślizgową	40 x 30 x 15	100 238 00	 4 052396 071740	PP/ TPE	5	720
18431 tomek „winnie“	trittthocker mit anti-rutsch-funktion step stool with anti-slip-function marchepied antidérapant podest dziecięcy z funkcją antypoślizgową	40,5 x 28,5 x 14	100 238 00	 4 052396 071788	PP/ TPE	5	400
							
10032 igor „winnie“	trittthocker zweistufig mit anti-rutsch-funktion double step stool with anti-slip-function double marchepied antidérapant podest dziecięcy dwustopniowy z funkcją antypoślizgową	40 x 37 x 21	100 238 00	 4 052396 071764	PP/ TPE	5	210
							

keeper

art.-bezeichnung cm/l
article description cm/l
désignation cm/l
opis produktu cm/l



farbe
colour
couleur
kolor

ean13
barcode
ean13
kod kreskowy

mat. mam pal.
mat. moq pal.
mat. moq pal.
mat. min. pal.

18496
amelia „winnie“



wickelunterlage 70 x 50 x 5
baby changing mat
matelas à langer
przewijak dziecięcy

100 238 00



PVC/ 3 75
PUR

18497
pawel „winnie“



wickelunterlage 70 x 50 x 10
mit messlatte

baby changing top
with measure

matelas à langer
avec point
de référence

przewijak-nakładka
na łóżeczko z miarką

100 238 00



PVC/ 2 28
PUR/
MDF

18500
antek „winnie“



reisewickelunterlage

travel mat

matelas à langer
de voyage

mata turystyczna

zusammengefaltet / folded / pliée / złożona:
29 x 13 x 5

ausgebreitet / assembled / dispersée / rozłożona:
58 x 40 x 0,5

100 238 00



PVC/ 8 768
PUR



art.-bezeichnung	cm/l	farbe	ean13	mat.	mam	pal.
article description	cm/l	colour	barcode	mat.	moq	pal.
désignation	cm/l	couleur	ean13	mat.	moq	pal.
opis produktu	cm/l	kolor	kod kreskowy	mat.	min.	pal.



12236
karolina „winnie“



dreh- & stapelbox
mit deckel 38 x 29,5 x 20,5 001 238 00
15 l



PP 5 160

turn-around stacking
box with lid

boîte empilable/
retournable avec
couvercle

skrzynka obrotowa
z pokrywą

12237
karolina „winnie“



dreh- & stapelbox
mit deckel 42,5 x 35,5 x 22,5 001 238 00
24 l



PP 5 120

turn-around stacking
box with lid

boîte empilable/
retournable avec
couvercle

skrzynka obrotowa
z pokrywą

12238
karolina „winnie“



dreh- & stapelbox
mit deckel 45 x 35 x 27 001 238 00
30 l



PP 5 90

turn-around stacking
box with lid

boîte empilable/
retournable avec
couvercle

skrzynka obrotowa
z pokrywą

12239
karolina „winnie“



dreh- & stapelbox
mit deckel 55,5 x 40 x 30 001 238 00
45 l



PP 5 60

turn-around stacking
box with lid

boîte empilable/
retournable avec
couvercle

skrzynka obrotowa
z pokrywą

keeper

art.-bezeichnung
article description
désignation
opis produktu

cm/l
cm/l
cm/l
cm/l



farbe
colour
couleur
kolor

ean13
barcode
ean13
kod kreskowy

mat. mam pal.
mat. moq pal.
mat. moq pal.
mat. min. pal.

11806
janek „winnie“



organizer box
zum einhängen
4 l

16 x 27 x 18

100 238 00



PP 6 384

hanging organizer
box

boîte de rangement
suspendue

organizer do
zawieszania

12202
patryk „winnie“

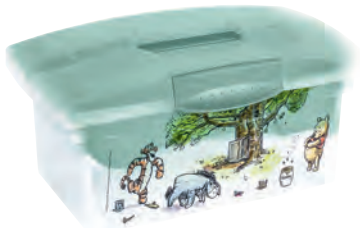

traveller
pojemnik traveller

40 x 24 x 21

315 238 00



PP 3 72

18501
lena „winnie“



auflage
für hochstuhl

100 238 00



PVC/ 6 192
PUR

feeding chair mat

tapis de chaise
d'alimentation

mata na krzeselko
do karmienia

zusammengebaut / assembled / assemblé / złożona::
22 x 23

flach / unfolded / ouvert / rozłożona:
63 x 63



puuh der bär

ist unverkäuflich.

pooh the bear
is not for sale.

winnie l'ourson
n'est pas à vendre.

miś nie jest na
sprzedaż.



keeper

art.-bezeichnung

article description
désignation
opis produktu

cm/l

cm/l
cm/l
cm/l



farbe

colour
couleur
kolor

ean13

barcode
ean13
kod kreskowy

mat. mam pal.

mat. moq pal.
mat. moq pal.
mat. min. pal.

18423
maria „minnie“



babywanne 84 cm
mit stöpsel 84 x 49 x 29

581 247 00



PP 5 255

baby bath 84 cm
with plug

baignoire 84 cm
avec vidange

wanienka 84 cm
z korkiem



18670
adam „minnie“



babytopf mit
anti-rutsch-funktion 38 x 27 x 23,5

581 247 00



PP/
TPE 5 855

potty with
anti-slip-function

pot bébé
antidérapant

nocnik z funkcją
antypoślizgową

10819
ewa „minnie“



kinder-toilettensitz
mit anti-rutsch-
funktion 40 x 30 x 15

581 247 00



PP/
TPE 5 720

toilet training seat
with anti-slip-function

réducteur de siège wc
antidérapant

nakładka sedesowa
z funkcją
antypoślizgową

18431
tomek „minnie“



trithocker mit
anti-rutsch-funktion 40,5 x 28,5 x 14

581 247 00



PP/
TPE 5 400

step stool with
anti-slip-function

marchepied
antidérapant

podest dziecięcy
z funkcją
antypoślizgową



10032
igor „minnie“



trithocker
zweistufig
mit anti-rutsch-funktion 40 x 37 x 21

581 247 00



PP/
TPE 5 210

double step stool
with anti-slip-function

double marchepied
antidérapant

podest dziecięcy
dwustopniowy
z funkcją antypoślizgową





art.-bezeichnung	cm/l	farbe	ean13	mat.	mam	pal.
article description	cm/l	colour	barcode	mat.	moq	pal.
désignation	cm/l	couleur	ean13	mat.	moq	pal.
opis produktu	cm/l	kolor	kod kreskowy	mat.	min.	pal.



12236
karolina „minnie“



dreh- & stapelbox mit deckel	38 x 29,5 x 20,5 15 l	581 247 00			PP	5	160
turn-around stacking box with lid				4 052396 081497			
boîte empilable/ retournable avec couvercle							
skrzynka obrotowa z pokrywą							

12237
karolina „minnie“



dreh- & stapelbox mit deckel	42,5 x 35,5 x 22,5 24 l	581 247 00			PP	5	120
turn-around stacking box with lid				4 052396 081510			
boîte empilable/ retournable avec couvercle							
skrzynka obrotowa z pokrywą							

12238
karolina „minnie“



dreh- & stapelbox mit deckel	45 x 35 x 27 30 l	581 247 00			PP	5	90
turn-around stacking box with lid				4 052396 081145			
boîte empilable/ retournable avec couvercle							
skrzynka obrotowa z pokrywą							

12239
karolina „minnie“



dreh- & stapelbox mit deckel	55,5 x 40 x 30 45 l	581 247 00			PP	5	60
turn-around stacking box with lid				4 052396 081169			
boîte empilable/ retournable avec couvercle							
skrzynka obrotowa z pokrywą							

keeper

art.-bezeichnung
article description
désignation
opis produktu

cm/l
cm/l
cm/l
cm/l



farbe
colour
couleur
kolor

ean13
barcode
ean13
kod kreskowy

mat. mam pal.
mat. moq pal.
mat. moq pal.
mat. min. pal.

11806
janek „minnie“



organizer box
zum einhängen
41

16 x 27 x 18

581 247 00



PP 6 384

hanging organizer
box

boîte de rangement
suspendue

organizer do
zawieszania

12202
patryk „minnie“



traveller
pojemnik traveller

40 x 24 x 21

581 247 00



PP 3 72

18501
lena „minnie“



aufgabe
für hochstuhl

555 247 00



PVC/ 6 192
PUR

feeding chair mat









tapis de chaise
d'alimentation

mata na krzeselko
do karmienia

zusammengebaut / assembled / assemblé / złożona::
22 x 23

flach / unfolded / ouvert / rozłożona:
63 x 63



	art.-bezeichnung article description désignation opis produktu	cm/l cm/l cm/l cm/l	farbe colour couleur kolor	ean13 barcode ean13 kod kreskowy	mat. mat. mat.	mam moq moq	pal. pal. pal. pal.
18423 maria „mickey“	babywanne 84 cm mit stöpsel baby bath 84 cm with plug baignoire 84 cm avec vidange wanienka 84 cm z korkiem	84 x 49 x 29	684 247 00	4 052396 073317	PP	5	255
							
18670 adam „mickey“	babytopf mit anti-rutsch-funktion potty with anti-slip-function pot bébé antidérapant nocnik z funkcją antypoślizgową	38 x 27 x 23,5	684 247 00	4 052396 073331	PP/ TPE	5	855
							
10819 ewa „mickey“	kinder-toilettensitz mit anti-rutsch-funktion toilet training seat with anti-slip-function réducteur de siège wc antidérapant nakładka sedesowa z funkcją antypoślizgową	40 x 30 x 15	684 247 00	4 052396 073355	PP/ TPE	5	720
							
18431 tomek „mickey“	trithocker mit anti-rutsch-funktion step stool with anti-slip-function marchepied antidérapant podest dziecięcy z funkcją antypoślizgową	40,5 x 28,5 x 14	684 247 00	4 052396 073379	PP/ TPE	5	400
							
10032 igor „mickey“	trithocker zweistufig mit anti-rutsch-funktion double step stool with anti-slip-function double marchepied antidérapant podest dziecięcy dwustopniowy z funkcją antypoślizgową	40 x 37 x 21	684 247 00	4 052396 073393	PP/ TPE	5	210
							

keeper

art.-bezeichnung	cm/l	farbe	ean13	mat.	mam	pal.
article description	cm/l	colour	barcode	mat.	moq	pal.
désignation	cm/l	couleur	ean13	mat.	moq	pal.
opis produktu	cm/l	kolor	kod kreskowy	mat.	min.	pal.



12236
karolina „mickey“



dreh- & stapelbox mit deckel	38 x 29,5 x 20,5	684 247 00			PP	5	160
	15 l			4 052396 081503			
turn-around stacking box with lid							
boîte empilable/retournable avec couvercle							
skrzynka obrotowa z pokrywą							

12237
karolina „mickey“



dreh- & stapelbox mit deckel	42,5 x 35,5 x 22,5	684 247 00			PP	5	120
	24 l			4 052396 081527			
turn-around stacking box with lid							
boîte empilable/retournable avec couvercle							
skrzynka obrotowa z pokrywą							

12238
karolina „mickey“



dreh- & stapelbox mit deckel	45 x 35 x 27	684 247 00			PP	5	90
	30 l			4 052396 081152			
turn-around stacking box with lid							
boîte empilable/retournable avec couvercle							
skrzynka obrotowa z pokrywą							

12239
karolina „mickey“



dreh- & stapelbox mit deckel	55,5 x 40 x 30	684 247 00			PP	5	60
	45 l			4 052396 081176			
turn-around stacking box with lid							
boîte empilable/retournable avec couvercle							
skrzynka obrotowa z pokrywą							



11806
janeq „mickey“



art.-bezeichnung cm/l
article description cm/l
désignation cm/l
opis produktu cm/l



farbe
colour
couleur
kolor

ean13
barcode
ean13
kod kreskowy

mat. mam pal.
mat. moq pal.
mat. moq pal.
mat. min. pal.

organizer box
zum einhängen
41

684 247 00



PP 6 384

hanging organizer
box

boîte de rangement
suspendue

organizer do
zawieszania

12202
patryk „mickey“



traveller
40 x 24 x 21
pojemnik traveller

684 247 00



PP 3 72

18501
lena „mickey“



auflage
für hochstuhl

684 247 00



PVC/
PUR 6 192

feeding chair mat

tapis de chaise
d'alimentation

mata na krzesetko
do karmienia

zusammengebaut / assembled / assemblé / złożona::
22 x 23

flach / unfolded / ouvert / rozłożona:
63 x 63

tobi

teilt seine möhrchen am liebsten
mit seinem allerbesten freund.

tobi prefers to share his little carrots
with his very best friend.

tobi partage ses carottes de préférence
avec son meilleur ami.

tobi woli się dzielić swoimi małymi
marchewkami ze swoim najlepszym
przyjacielem.



keeper

art.-bezeichnung

article description
désignation
opis produktu

cm/l

cm/l
cm/l
cm/l



farbe

colour
couleur
kolor

ean13

barcode
ean13
kod kreskowy

mat. mam pal.

mat. moq pal.
mat. moq pal.
mat. min. pal.

131



18423
maria „bambi“



babywanne 84 cm
mit stöpsel 84 x 49 x 29

519 266 00



PP 5 255

baby bath 84 cm
with plug

baignoire 84 cm
avec vidange

wanienka 84 cm
z korkiem



18670
adam „bambi“



babytopf mit
anti-rutsch-funktion 38 x 27 x 23,5

519 266 00



PP/ 5 855
TPE

potty with
anti-slip-function

pot bébé
antidérapant

nocnik z funkcją
antypoślizgową

10819
ewa „bambi“



kinder-toilettensitz
mit anti-rutsch-
funktion 40 x 30 x 15

519 266 00



PP/ 5 720
TPE

toilet training seat
with anti-slip-function

réducteur de siège wc
antidérapant

nakładka sedesowa
z funkcją
antypoślizgową

18431
tomek „bambi“



trithocker mit
anti-rutsch-funktion 40,5 x 28,5 x 14

519 266 00



PP/ 5 400
TPE

step stool with
anti-slip-function

marchepied
antidérapant

podest dziecięcy
z funkcją
antypoślizgową



10032
igor „bambi“



trithocker
zweistufig
mit anti-rutsch-funktion 40 x 37 x 21

519 266 00



PP/ 5 210
TPE

double step stool
with anti-slip-function

double marchepied
antidérapant

podest dziecięcy
dwustopniowy
z funkcją antypoślizgową



keeper

art.-bezeichnung	cm/l	farbe	ean13	mat.	mam	pal.
article description	cm/l	colour	barcode	mat.	moq	pal.
désignation	cm/l	couleur	ean13	mat.	moq	pal.
opis produktu	cm/l	kolor	kod kreskowy	mat.	min.	pal.



12236
karolina „bambi“



dreh- & stapelbox mit deckel	38 x 29,5 x 20,5	001 266 00		PP	5	160
turn-around stacking box with lid	15 l					
boîte empilable/retournable avec couvercle						
skrzynka obrotowa z pokrywą						

12237
karolina „bambi“



dreh- & stapelbox mit deckel	42,5 x 35,5 x 22,5	001 266 00		PP	5	120
turn-around stacking box with lid	24 l					
boîte empilable/retournable avec couvercle						
skrzynka obrotowa z pokrywą						

12238
karolina „bambi“



dreh- & stapelbox mit deckel	45 x 35 x 27	001 266 00		PP	5	90
turn-around stacking box with lid	30 l					
boîte empilable/retournable avec couvercle						
skrzynka obrotowa z pokrywą						

12239
karolina „bambi“



dreh- & stapelbox mit deckel	55,5 x 40 x 30	001 266 00		PP	5	60
turn-around stacking box with lid	45 l					
boîte empilable/retournable avec couvercle						
skrzynka obrotowa z pokrywą						

greta

kennst alle geheimverstecke
der waldbewohner.

greta knows all the secret hiding places
of the forest dwellers.

greta connaît toutes les cachettes secrètes
des habitants de la forêt.

greta zna wszystkie sekretne kryjówki
mieszkańców lasu



keeper

art.-bezeichnung	cm/l	farbe	ean13	mat.	mam	pal.
article description	cm/l	colour	barcode	mat.	moq	pal.
désignation	cm/l	couleur	ean13	mat.	moq	pal.
opis produktu	cm/l	kolor	kod kreskowy	mat.	min.	pal.



18670
adam „peppa“



babytopf mit
anti-rutsch-funktion 38 x 27 x 23,5

519 194 00



PP/ 5 855
TPE

potty with
anti-slip-function

pot bébé
antidérapant

nocnik z funkcją
antypoślizgową

10819
ewa „peppa“



kinder-toilettensitz
mit anti-rutsch-
funktion 40 x 30 x 15

519 194 00



PP/ 5 720
TPE

toilet training seat
with anti-slip-function

réducteur de siège wc
antidérapant

nakładka sedesowa
z funkcją
antypoślizgową

18431
tomek „peppa“



trittthocker mit
anti-rutsch-funktion 40,5 x 28,5 x 14

519 194 00



PP/ 5 400
TPE

step stool with
anti-slip-function

marchepied
antidérapant

podest dziecięcy
z funkcją
antypoślizgową



10032
igor „peppa“



trittthocker
zweistufig
mit anti-rutsch-funktion 40 x 37 x 21

519 194 00



PP/ 5 210
TPE

double step stool
with anti-slip-function

double marchepied
antidérapant

podest dziecięcy
dwustopniowy
z funkcją antypoślizgową





	art.-bezeichnung article description désignation opis produktu	cm/l cm/l cm/l cm/l	farbe colour couleur kolor	ean13 barcode ean13 kod kreskowy	mat. mat. mat.	mam moq moq	pal. pal. pal. pal.
12236 karolina „peppa“	dreh- & stapelbox mit deckel turn-around stacking box with lid boîte empilable/ retournable avec couvercle skrzynka obrotowa z pokrywą	38 x 29,5 x 20,5 15 l	001 194 00	 4 052396 081664	PP	5	160
12237 karolina „peppa“	dreh- & stapelbox mit deckel turn-around stacking box with lid boîte empilable/ retournable avec couvercle skrzynka obrotowa z pokrywą	42,5 x 35,5 x 22,5 24 l	001 194 00	 4 052396 081671	PP	5	120
12238 karolina „peppa“	dreh- & stapelbox mit deckel turn-around stacking box with lid boîte empilable/ retournable avec couvercle skrzynka obrotowa z pokrywą	45 x 35 x 27 30 l	001 194 00	 4 052396 081688	PP	5	90
12239 karolina „peppa“	dreh- & stapelbox mit deckel turn-around stacking box with lid boîte empilable/ retournable avec couvercle skrzynka obrotowa z pokrywą	55,5 x 40 x 30 45 l	001 194 00	 4 052396 081695	PP	5	60

keeper

art.-bezeichnung	cm/l	farbe	ean13	mat.	mam	pal.
article description	cm/l	colour	barcode	mat.	maq	pal.
désignation	cm/l	couleur	ean13	mat.	maq	pal.
opis produktu	cm/l	kolor	kod kreskowy	mat.	min.	pal.



18670
adam „paw patrol“



babytopf mit
anti-rutsch-funktion 38 x 27 x 23,5

100 293 00



PP/ 5 855
TPE

potty with
anti-slip-function

pot bébé
antidérapant

nocnik z funkcją
antypoślizgową

10819
ewa „paw patrol“



kinder-toilettensitz
mit anti-rutsch-
funktion 40 x 30 x 15

100 293 00



PP/ 5 720
TPE

toilet training seat
with anti-slip-function

réducteur de siège wc
antidérapant

nakładka sedesowa
z funkcją
antypoślizgową

18431
tomek „paw patrol“



trittthocker mit
anti-rutsch-funktion 40,5 x 28,5 x 14

100 293 00



PP/ 5 400
TPE

step stool with
anti-slip-function

marchepied
antidérapant

podest dziecięcy
z funkcją
antypoślizgową



10032
igor „paw patrol“



trittthocker
zweistufig
mit anti-rutsch-funktion 40 x 37 x 21

100 293 00



PP/ 5 210
TPE

double step stool
with anti-slip-function

double marchepied
antidérapant

podest dziecięcy
dwustopniowy
z funkcją antypoślizgową





art.-bezeichnung	cm/l	farbe	ean13	mat.	mam	pal.
article description	cm/l	colour	barcode	mat.	moq	pal.
désignation	cm/l	couleur	ean13	mat.	moq	pal.
opis produktu	cm/l	kolor	kod kreskowy	mat.	min.	pal.



12236
karolina „paw patrol“



dreh- & stapelbox mit deckel 38 x 29,5 x 20,5 632 137 00
15 l



PP 5 160

turn-around stacking box with lid

boîte empilable/
retournable avec couvercle

skrzynka obrotowa z pokrywą

12237
karolina „paw patrol“



dreh- & stapelbox mit deckel 42,5 x 35,5 x 22,5 632 137 00
24 l



PP 5 120

turn-around stacking box with lid

boîte empilable/
retournable avec couvercle

skrzynka obrotowa z pokrywą

12238
karolina „paw patrol“



dreh- & stapelbox mit deckel 45 x 35 x 27 632 137 00
30 l



PP 5 90

turn-around stacking box with lid

boîte empilable/
retournable avec couvercle

skrzynka obrotowa z pokrywą

12239
karolina „paw patrol“



dreh- & stapelbox mit deckel 55,5 x 40 x 30 632 137 00
45 l



PP 5 60

turn-around stacking box with lid

boîte empilable/
retournable avec couvercle

skrzynka obrotowa z pokrywą



pauline

pustet seifenblasen in allen
farben des regenbogens.

pauline blows bubbles in all the colours of
the rainbow.

pauline fait des bulles de savon de toutes
les couleurs de l'arc-en-ciel.

paulina dmucha bańki we wszystkich
kolorach tęczy.



keeper

art.-bezeichnung cm/l
article description cm/l
désignation cm/l
opis produktu cm/l

farbe
colour
couleur
kolor

ean13
barcode
ean13
kod kreskowy

mat. **mam** **pal.**
mat. **moq** **pal.**
mat. **min.** **pal.**

139



18426
maria „rainbow“



babywanne 84 cm mit Stöpsel 84 x 49 x 29

100 297 00



PP 5 255

baby bath 84 cm with plug

baignoire 84 cm avec vidange

wanienka 84 cm z korkiem



18648
adam „rainbow“



babytopf mit anti-rutsch-funktion 38 x 27 x 23,5

100 297 00



PP/TPE 5 855

potty with anti-slip-function

pot bébé antidérapant

nocnik z funkcją antypoślizgową

18650
ewa „rainbow“



kinder-toilettensitz mit anti-rutsch-funktion 40 x 30 x 15

100 297 00



PP/TPE 5 720

toilet training seat with anti-slip-function

réducteur de siège wc antidérapant

nakładka sedesowa z funkcją antypoślizgową

18642
tomek „rainbow“

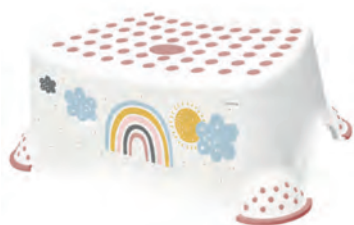

trithocker mit anti-rutsch-funktion 40,5 x 28,5 x 14

100 297 00



PP/TPE 5 400

step stool with anti-slip-function

marchepied antidérapant

podest dziecięcy z funkcją antypoślizgową



10031
igor „rainbow“



trithocker zweistufig mit anti-rutsch-funktion 40 x 37 x 21

100 297 00



PP/TPE 5 210

double step stool with anti-slip-function

double marchepied antidérapant

podest dziecięcy dwustopniowy z funkcją antypoślizgową



keeper

art.-bezeichnung cm/l
 article description cm/l
 désignation cm/l
 opis produktu cm/l

farbe
 colour
 couleur
 kolor

ean13
 barcode
 ean13
 kod kreskowy

mat. mam pal.
 mat. moq pal.
 mat. moq pal.
 mat. min. pal.



18426
maria „stars“



babywanne 84 cm mit stöpsel 84 x 49 x 29
 baby bath 84 cm with plug
 baignoire 84 cm avec vidange
 wanienka 84 cm z korkiem

130 196 00



PP 5 255



18648
adam „stars“

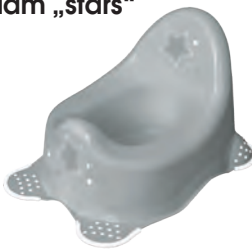

babytopf mit anti-rutsch-funktion 38 x 27 x 23,5
 potty with anti-slip-function
 pot bébé antidérapant
 nocnik z funkcją antypoślizgową

130 196 00



PP/ TPE 5 855

18650
ewa „stars“



kinder-toilettensitz mit anti-rutsch-funktion 40 x 30 x 15
 toilet training seat with anti-slip-function
 réducteur de siège wc antidérapant
 nakładka sedesowa z funkcją antypoślizgową

130 196 00



PP/ TPE 5 720

18642
tomek „stars“



trithocker mit anti-rutsch-funktion 40,5 x 28,5 x 14
 step stool with anti-slip-function
 marche pied antidérapant
 podest dziecięcy z funkcją antypoślizgową

130 196 00



PP/ TPE 5 400



10031
igor „stars“



trithocker zweistufig mit anti-rutsch-funktion 40 x 37 x 21
 double step stool with anti-slip-function
 double marche pied antidérapant
 podest dziecięcy dwustopniowy z funkcją antypoślizgową

130 196 00



PP/ TPE 5 210





	art.-bezeichnung article description désignation opis produktu	cm/l cm/l cm/l cm/l	farbe colour couleur kolor	ean13 barcode ean13 kod kreskowy	mat. mat. mat. mat.	mam maq moq min.	pal. pal. pal. pal.
18426 maria „stars“ 	babywanne 84 cm mit stöpsel baby bath 84 cm with plug baignoire 84 cm avec vidange wanienka 84 cm z korkiem	84 x 49 x 29	519 196 00	  4 052396 048438	PP	5	255
							
18648 adam „stars“ 	babytopf mit anti-rutsch-funktion potty with anti-slip-function pot bébé antidérapant nocnik z funkcją antypoślizgową	38 x 27 x 23,5	519 196 00	  4 052396 045031	PP/ TPE	5	855
18650 ewa „stars“ 	kinder-toilettensitz mit anti-rutsch- funktion toilet training seat with anti-slip-function réducteur de siège wc antidérapant nakładka sedesowa z funkcją antypoślizgową	40 x 30 x 15	519 196 00	  4 052396 044898	PP/ TPE	5	720
18642 tomek „stars“ 	tritthocker mit anti-rutsch-funktion step stool with anti-slip-function marche pied antidérapant podest dziecięcy z funkcją antypoślizgową	40,5 x 28,5 x 14	519 196 00	  4 052396 045017	PP/ TPE	5	400
							
10031 igor „stars“ 	tritthocker zweistufig mit anti-rutsch-funktion double step stool with anti-slip-function double marche pied antidérapant podest dziecięcy dwustopniowy z funkcją antypoślizgową	40 x 37 x 21	519 196 00	  4 052396 044874	PP/ TPE	5	210
							

keeper

art.-bezeichnung	cm/l	farbe	ean13	mat.	mam	pal.
article description	cm/l	colour	barcode	mat.	moq	pal.
désignation	cm/l	couleur	ean13	mat.	moq	pal.
opis produktu	cm/l	kolor	kod kreskowy	mat.	min.	pal.



12240
karolina „stars“



dreh- & stapelbox
mit deckel 38 x 29,5 x 20,5 519 196 00



PP 5 160

15 l
turn-around stacking
box with lid

boîte empilable/
retournable avec
couvercle

skrzynka obrotowa
z pokrywą

12241
karolina „stars“



dreh- & stapelbox
mit deckel 42,5 x 35,5 x 22,5 519 196 00



PP 5 120

24 l
turn-around stacking
box with lid

boîte empilable/
retournable avec
couvercle

skrzynka obrotowa
z pokrywą

12242
karolina „stars“



dreh- & stapelbox
mit deckel 45 x 35 x 27 519 196 00



PP 5 90

30 l
turn-around stacking
box with lid

boîte empilable/
retournable avec
couvercle

skrzynka obrotowa
z pokrywą

12243
karolina „stars“



dreh- & stapelbox
mit deckel 55,5 x 40 x 30 519 196 00



PP 5 60

45 l
turn-around stacking
box with lid

boîte empilable/
retournable avec
couvercle

skrzynka obrotowa
z pokrywą



lars & lilly

wünschen sich was – nämlich
immer freunde zu bleiben.

lars & lilly wish to be friends forever.

lars & lilly voudraient être amis
pour toujours.

lars & lilly chcą zostać
przyjaciółmi na zawsze.



11805 janek „stars“



organizer box
zum einhängen
41

519 196 00



PP 6 384

hanging organizer
box

boîte de rangement
suspendue

organizer do
zawieszania

12203 patryk „stars“



traveller
pojemnik traveller

519 196 00



PP 3 72

roxy & tuana

möchten mit den hennen
rennen fahren.

roxy & tuana want to race
the hens.

roxy & tuana veulent faire une
course avec les poules.

roxy & tuana chcą ścigać
się z kurami.



18426 maria „funny farm“



babywanne 84 cm 84 x 49 x 29
mit stöpsel

315 063 00



PP

5

255

baby bath 84 cm
with plug

baignoire 84 cm
avec vidange

wanienka 84 cm
z korkiem



18436 wiktoria „funny farm“



babywanne 84 cm 84 x 49 x 29

315 063 00



PP

5

255

baby bath 84 cm

baignoire 84 cm

wanienka 84 cm

18437 wiktoria „funny farm“



babywanne 100 cm 100 x 51 x 29

315 063 00



PP

5

200

baby bath 100 cm

baignoire 100 cm

wanienka 100 cm

keeper

art.-bezeichnung

article description
désignation
opis produktu

cm/l

cm/l
cm/l
cm/l



farbe

colour
couleur
kolor

ean13

barcode
ean13
kod kreskowy

mat. mam pal.

mat. moq pal.
mat. moq pal.
mat. min. pal.

145



18648

adam „funny farm“



babytopf mit
anti-rutsch-funktion

38 x 27 x 23,5

315 063 00



PP/
TPE

5

855

potty with
anti-slip-function

pot bébé
antidérapant

nocnik z funkcją
antypoślizgową

18650

ewa „funny farm“



kinder-toilettensitz
mit anti-rutsch-
funktion

40 x 30 x 15

315 063 00



PP/
TPE

5

720

toilet training seat
with anti-slip-
function

réducteur de siège wc
antidérapant

nakładka
sedesowa
z funkcją
antypoślizgową

18642

tomek „funny farm“



trittthocker mit
anti-rutsch-funktion

40,5 x 28,5 x 14

315 063 00



PP/
TPE

5

400

step stool with
anti-slip-function

marchepied
antidérapant

podest dziecięcy
z funkcją
antypoślizgową



10031

igor „funny farm“



trittthocker
zweistufig
mit anti-rutsch-funktion

40 x 37 x 21

315 063 00



PP/
TPE

5

210

double step stool
with anti-slip-function

double marchepied
antidérapant

podest dziecięcy
dwustopniowy
z funkcją antypoślizgową



keeper

art.-bezeichnung cm/l
article description cm/l
désignation cm/l
opis produktu cm/l



farbe
colour
couleur
kolor

ean13
barcode
ean13
kod kreskowy

mat. mam pal.
mat. moq pal.
mat. moq pal.
mat. min. pal.

18426
maria „hippo“



babywanne 84 cm 84 x 49 x 29
 mit stöpsel

baby bath 84 cm
 with plug

baignoire 84 cm
 avec vidange

wanienka 84 cm
 z korkiem



100 012 NN



PP 5 255

18436
wiktoria „hippo“



babywanne 84 cm 84 x 49 x 29

baby bath 84 cm

baignoire 84 cm

wanienka 84 cm

100 012 NN



PP 5 255

18437
wiktoria „hippo“



babywanne 100 cm 100 x 51 x 29

baby bath 100 cm

baignoire 100 cm

wanienka 100 cm

100 012 NN



PP 5 200

18648
adam „hippo“



babytopf mit 38 x 27 x 23,5
 anti-rutsch-funktion

potty with
 anti-slip-function

pot bébé
 antidérapant

nocnik z funkcją
 antypoślizgową

100 012 00



PP/ 5 855
 TPE



nils

hat nur augen für mama.

nils only has eyes for
mommy.

nils n'a d'yeux que
pour maman.

nils jest wpatrzony
w mamę.

18650 ewa „hippo“



kinder-toilettensitz
mit anti-rutsch-
funktion 40 x 30 x 15

100 012 NN



PP/
TPE 5

720

toilet training seat
with anti-slip-
function

réducteur de siège wc
antidérapant

nakładka
sedesowa
z funkcją
antypoślizgową

18642 tomek „hippo“



trittthocker mit
anti-rutsch-funktion 40,5 x 28,5 x 14

100 012 NN



PP/
TPE 5

400

step stool with
anti-slip-function

marchepied
antidérapant

podest dziecięcy
z funkcją
antypoślizgową



10031 igor „hippo“



trittthocker
zweistufig
mit anti-rutsch-funktion 40 x 37 x 21

100 012 NN



PP/
TPE 5

210

double step stool
with anti-slip-function

double marchepied
antidérapant

podest dziecięcy
dwustopniowy
z funkcją antypoślizgową



keeper

art.-bezeichnung	cm/l	farbe	ean13	mat.	mam	pal.
article description	cm/l	colour	barcode	mat.	moq	pal.
désignation	cm/l	couleur	ean13	mat.	moq	pal.
opis produktu	cm/l	kolor	kod kreskowy	mat.	min.	pal.



10342
maria „pure“



babywanne 84 cm 84 x 49 x 29
mit stöpsel

baby bath 84 cm
with plug

baignoire 84 cm
avec vidange

wanienka 84 cm
z korkiem

581 000 00



PP 5 255

680 000 00



10334
wiktorja „pure“



babywanne 84 cm 84 x 49 x 29

baby bath 84 cm

baignoire 84 cm

wanienka 84 cm

581 000 00



PP 5 255

680 000 00



10336
wiktorja „pure“



babywanne 100 cm 100 x 51 x 29

baby bath 100 cm

baignoire 100 cm

wanienka 100 cm

581 000 00



PP 5 200

680 000 00



10013
tomek „pure“

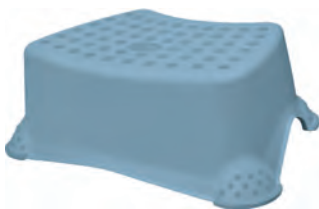

trifthocker mit
anti-rutsch-funktion 40,5 x 28,5 x 14

step stool with
anti-slip-function

marchepied
antidérapant

podest dziecięcy
z funkcją
antypoślizgową

581 000 00



PP/
TPE 5 400

680 000 00



10029
igor „pure“



trifthocker 40 x 37 x 21
zweistufig
mit anti-rutsch-funktion

double step stool
with anti-slip-function

double marchepied
antidérapant

podest dziecięcy
dwustopniowy
z funkcją antypoślizgową

581 000 00













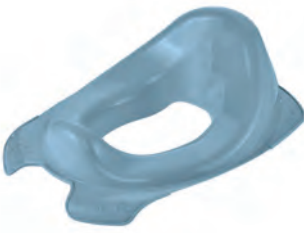

PP/
TPE 5 210

680 000 00





	art.-bezeichnung article description désignation opis produktu	cm/l cm/l cm/l cm/l	farbe colour couleur kolor	ean13 barcode ean13 kod kreskowy	mat. mat. mat.	mam moq min.	pal. pal. pal. pal.
18676 adam „pure“ 	babytopf mit anti-rutsch-funktion	38 x 27 x 23,5	581 000 00	 4 052396 093193	PP/ TPE	5	855
	potty with anti-slip-function		680 000 00	 4 052396 093209			
10060 franek „pure“ 	babytopf comfort	30 x 25 x 22	581 000 00	 4 052396 093254	PP	5	720
	potty comfort		680 000 00	 4 052396 093261			
18595 ewa „pure“ 	kinder-toilettensitz mit anti-rutsch- funktion	40 x 30 x 15	581 000 00	 4 052396 093216	PP/ TPE	5	720
	toilet training seat with anti-slip- function		680 000 00	 4 052396 093223			
10074 zuza „pure“ 	kinder-toilettensitz comfort	28 x 37 x 14	581 000 00	 4 052396 093278	PP	5	960
	toilet training seat comfort		680 000 00	 4 052396 093285			



keeper

art.-bezeichnung
article description
désignation
opis produktu

cm/l
cm/l
cm/l
cm/l
↔ ↔ ↑

farbe
colour
couleur
kolor

ean13
barcode
ean13
kod kreskowy

mat. mam pal.
mat. moq pal.
mat. moq pal.
mat. min. pal.

10571
kamil „pure“



piraten-box
pirate box
boîte pirate
pojemnik pirat-box

58 x 37 x 40

581 000 00



PP 4 80

680 000 00



18596
miro „pure“



babytopf
deluxe 3in1

30 x 34 x 18,5

581 000 00



PP/
TPE 2 64

potty
deluxe 3in1

680 000 00



pot bébé
deluxe 3en1

nocnik
deluxe 3in1

10647
maja



faltbare
babywanne

48 x 82 x 23,5

130 000 00



PP/
TPE 5 36

foldable
baby bath

33 l

581 000 00



baignoire
bébé pliable

684 000 00



wanienka składana
dla dzieci



maja

ist mamas mini me.

maja is mommys mini me.

maja est le mini-moi de maman.

maja to mini wersja mamy.





elvis

formt seine haare
mit schaumfestiger.

elvis styles his hair with
styling mousse.

elvis modèle ses cheveux
avec une mousse coiffante.

elvis układa swoje włosy
za pomocą piany.



10015 dawid



universalständer
für babywannen
84/100 cm

100 000 NN



steel 1

20

universal stand for bathtubs
84/100 cm

piéd universel pour baignoires
84/100 cm

uniwersalny stojak
do wanienki 84/100 cm

zusammengeklappt / folded / plié / złożony:
84 cm: 127 x 55 x 40 cm
100 cm: 127 x 55 x 48 cm

aufgestellt / assembled / déplié / rozłożony:
84 cm: 97 x 55 x 85 cm
100 cm: 97 x 55 x 95 cm



10340 iwona



babybadenez

133 185 00



PUR/ 5
PP/
polyester/
cotton

810

baby bath net

hamac de bain pour bébé

siatka do wanienki dla niemowląt

produkt / product / produit / produkt: 71 x 103 x 1 cm

verkaufsverpackung / sales packaging /
emballage pour la vente / opakowanie sprzedażowe:
20,5 x 15,5 x 6,5 cm

keeper

dekore/decors/décors/dekory



012 – hippo



238 – winnie



284 – space tour



063 – funny farm



247 – minnie/mickey



285 – sea life



137 – paw patrol



266 – bambi



286 – magic ice



194 – peppa pig



282 – sandwich



293 – paw patrol



196 – stars



283 – sweet day



297 – rainbow

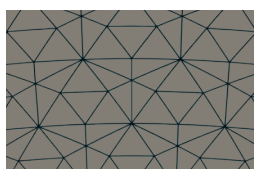

217 – polygon

PE Polyethylen / Polyethylene / Polyéthylène / Polietylen

PP Polypropylen / Polypropylene / Polypropylène / Polipropylen

PS Polystyrol / Polystyrene / Polystyrène / Polystyrol

PUR Polyurethanschaum / Polyurethane Foam / Mousse de Polyurethane / Płanka poliuretanowa

TPE Thermoplastisches Polyurethan Elastomer / Thermoplastic Polyurethan Elastomere / Thermoplastique / Poliuretan termoplastyczny Elastomery

POM Polyoxymethylen / Polyoxymethylene / Polyoxyméthylène / Polioksymetylen

SAN Styrol-Acrylnitril / Styrene Acrylnitrile / Acrylonitrile styrène / Styrenoakrylonitril

SMMA Styrol-Methyl-Methacrylat / Styrene-Methyl Methacrylate / Méthacrylate de Styrène-Méthyl Styren - metakrylan metylu

PVC Polyvinylchlorid / Polyvinyl chloride / Chlorure de polyvinyle / Chlorek winylu

MDF Faserplatte / Fiberboard / Panneau de fibres / MDF - płyta meblowa

↔ Breite / Width / Largeur / Szerokość

↗ Länge / Length / Longueur / Długość

↕ Höhe / Height / Hauteur / Wysokość



keeper

farben/colors/coloris/kolory



keeper

symbole/symbols/symboles/symbole



geeignet für Lebensmittelkontakt / suitable for food contact / adapté au contact avec des produits alimentaires / bezpieczne do kontaktu z żywnością



laugenbeständig / acid-resistant / résistant aux alcalis / odporność na kwasy i alkalia



Clip mit air control / clip with air control / clip avec air control / klip do wentylacji



mikrowellengeeignet 400 W max. 3 Min. / suitable for microwave 400 W max. 3 min. / convient pour le micro-ondes 400 W max. 3 min. / nadaje się do mikrofalówki 400 W max. 3 min.



Nutzungstemperatur / operating temperature / température d'utilisation / bezpieczna temperatura użytku



Tragkraft / capacity / capacité / nośność



spülmaschinengeeignet / dishwasher-safe / résistant au lave-vaisselle / nadaje się do mycia w zmywarce



kristallklar / crystal clear / clair comme de l'eau de roche / kryształczność



Größe Müllbeutel / size garbage bags / sac compatible / rozmiar worków na śmieci



tiefkühlgeeignet / suitable for freezing / adapté à la surgélation / nadaje się do zamrażania



wasserdicht / waterproof / imperméable à l'eau / wodoodporność



patentiert / patented / breveté / patent



impressum

rechtliche hinweise

keeper GmbH
industriehafen 9–25
32479 hille | germany

fon +49 5773 801-0
fax +49 5773 801-50

info@**keeper**.com
www.**keeper**.com

Copyright 2024 © **keeper** GmbH
Alle Rechte vorbehalten.

Nachdruck sowie Vervielfältigungen, auch auszugsweise, sind ohne ausdrückliche Genehmigung der **keeper** GmbH nicht gestattet.

Druckfehler, Irrtümer, Farb- und Modelländerungen vorbehalten.

Alle Maße sind Circaangaben.

Mit Erscheinen dieses Kataloges verlieren alle bisherigen Kataloge ihre Gültigkeit.

Gedruckt auf 100 % Recyclingpapier.

imprint

legal information

keeper GmbH
industriehafen 9–25
32479 hille | germany

fon +49 5773 801-0
fax +49 5773 801-50

info@**keeper**.com
www.**keeper**.com

Copyright 2024 © **keeper** GmbH
All rights withheld.

Reprints and duplication, even extracts, without express consent from **keeper** GmbH are not permitted.

All rights for misprints, errors, colour and design modifications withheld.

All measurements are approximate.

All previous catalogues cease to be valid upon publication of this catalogue.

Printed on 100 % recycled paper.

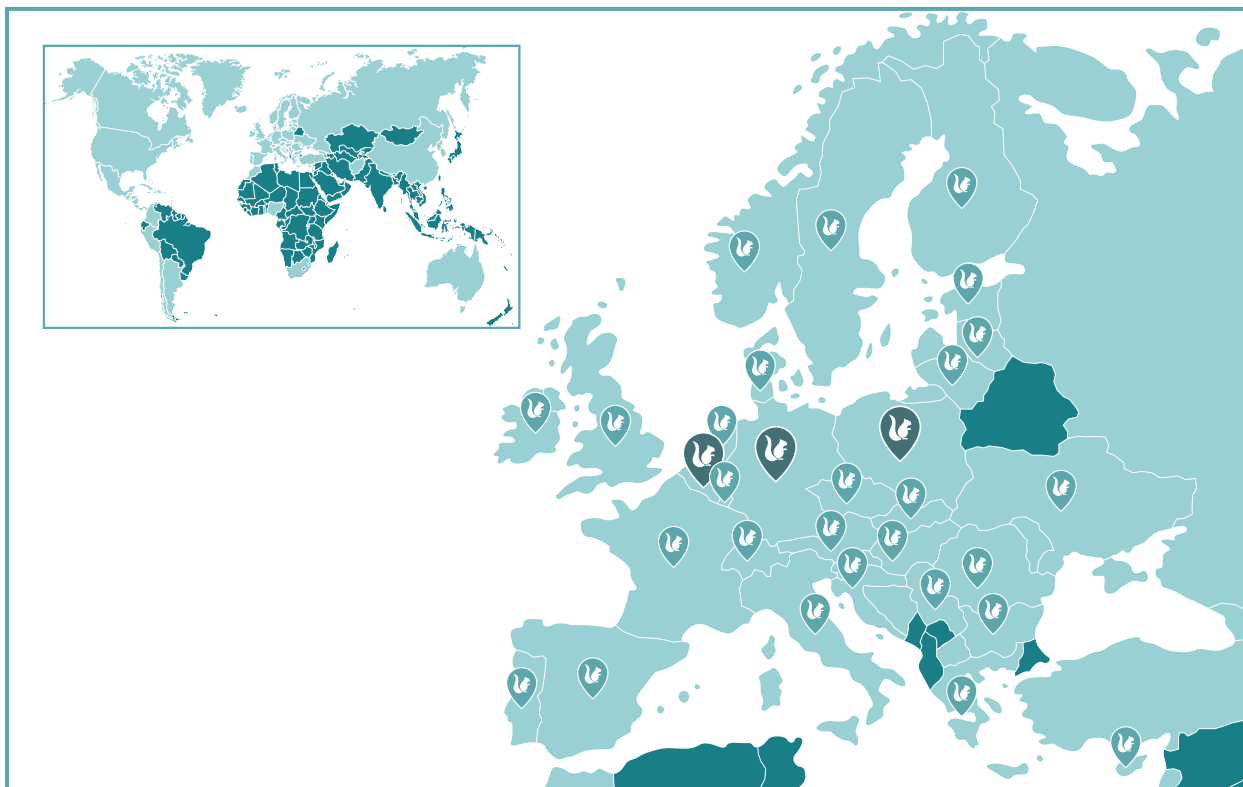

empreinte

mentions légales

keepeer GmbH
 Industriehafen 9–25
 32479 hille | germany

fon +49 5773 801-0
 fax +49 5773 801-50

info@**keepeer**.com
 www.**keepeer**.com

Copyright 2024 © keepeer GmbH
 Tous droits réservés.

La reproduction et l'utilisation de ce document sont interdites sans l'approbation de **keepeer** GmbH.

Tous droits réservés pour les erreurs d'impression, les erreurs, et les modifications de couleur et de motifs.

Toutes les mesures sont noncontractuelles.

Avec la parution de ce catalogue, tous les catalogues précédents perdent leurs validités.

Imprimé sur du papier 100 % recyclé.

impressum

informacje prawne

keepeer sp. z o. o.
 ul. mokra 3
 PL - 85-810 bydgoszcz

fon +48 52 3604-500
 fax +48 52 3604-506

info@**keepeer**.pl
 www.**keepeer**.com/pl

Copyright 2024 © **keepeer** GmbH
 Wszelkie prawa zastrzeżone.

Przedruki i powielanie, nawet we fragmentach, bez wyraźnej zgody **keepeer** GmbH nie są dozwolone.

Nie ponosimy odpowiedzialności za błędy drukarskie, pomyłki i różnice kolorystyczne.

Wzornictwo zastrzeżone. Wszystkie pomiary są przybliżone.

Wszystkie wcześniejsze katalogi tracą ważność po opublikowaniu niniejszego katalogu.

Wydrukowano na papierze pochodzącym w 100 % z recyklingu.



keeper.com

